

LAYHER ALLROUND SCAFFOLDING SYSTEM® CATALOGUE



Edition 04.2013
Ref. No. 8116.250

Quality management
certified according
to ISO 9001:2008
by German TÜV-CERT



QUALITY MADE BY LAYHER



// Headquarters in Eibensbach



// Plant II in Gueglingen

// HERE IS THE BEATING HEART OF LAYHER.

Quality made by Layher comes from Gueglingen-Eibensbach. Our company has set down deep local roots since it was established. Right up until today, development, production, logistics and management are all in one place, where the conditions are best for achieving quality made by Layher: in Gueglingen-Eibensbach. The two locations together cover a surface area of 318,000 m². This includes more than 142,000 m² of production and storage areas. This is where our scaffolding systems are created by highly automated production. Short distances and short reaction times mean we can adapt production to suit our customers' requirements, flexibly and at any time.

// MORE POSSIBILITIES. THE SCAFFOLDING SYSTEM.

This brand promise made by Layher is the expression of a brand philosophy that we've been living by for over 65 years. More speed, more safety, more proximity, more simplicity and more future: values with which we strengthen our customers' competitiveness in the long term. With our innovative systems and solutions, we're working all the time on making scaffolding construction even simpler, even more economical and, above all, even safer. With comprehensive services, a permanent range of training courses and an ethos of customer focus, more than 1,500 dedicated Layher employees are creating more possibilities for our customers every single day. In more than 30 countries all over the world.



// MORE SPEED

We can supply any required quantity of the right products at the right time – to anywhere in the world. Layher has subsidiaries in more than 30 countries in all five continents, with a tight-knit network of national service centers. Speed is also the motto of our logistics concept. Customers have the choice of picking up their material at a Layher service center or having it delivered either to a warehouse or “just in time” directly to the site.



// MORE EXPERIENCE

Tradition has grown into experience and expertise. Our experts pass on this knowledge – all over the world. Existing customers might want to try a different approach, while new customers might need support when assembling a Layher scaffolding structure. Layher's specialists get to grips with the specific tasks and requirements, devising for our customers persuasive solutions that are both profitable and efficient. Good advice from Layher is guaranteed. We take care of our customers at every level, because cooperation with them on the basis of mutual trust as well as their success are important to us.



// MORE KNOWLEDGE

Further training is the key to success. For this reason, Layher organizes regular training seminars that prepare our customers for current and future challenges specifically in scaffolding. This training scheme is backed up by many other options, for example practical product training courses and regular meetings for scaffolding erectors to promote the flow of information between experts and colleagues. And last but not least, Layher offers comprehensive publications on all topics to do with scaffolding construction.



// MORE CLARITY

Saving time, using material in the best way, improving logistics. All that can be done with Layher's planning software, LayPLAN, or the special Layher tools for AutoCAD®. Layher software means greater reliability when budgeting and planning scaffolding construction projects. Optimization of inventory management and complete cost transparency for the material used in a project. Once the dimensions and the required assembly variant have been entered, the Layher software supplies a scaffolding proposal with matching material list within seconds.



// MORE QUALITY

People talk a lot about quality. We just produce it. Quality from Layher means state-of-the-art production processes, carefully selected materials, smart automation and a highly qualified workforce. Our products comply with the very latest security standards and possess DIN/ISO certification, German TÜV approval, and many other German and international quality labels. 20,000 kilometers of steel tubing in high-quality workmanship are convincing testimony to Layher's quality standards.

LAYHER ALLROUND SCAFFOLDING SYSTEM®

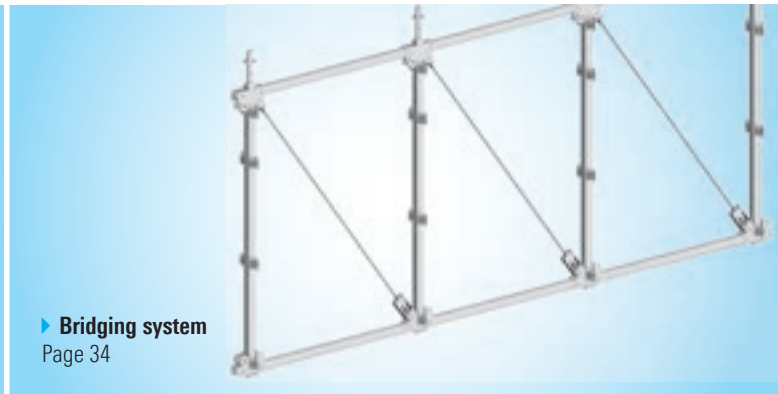
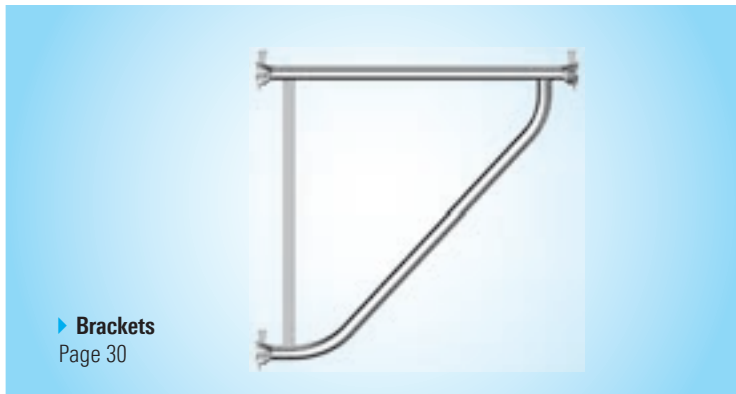
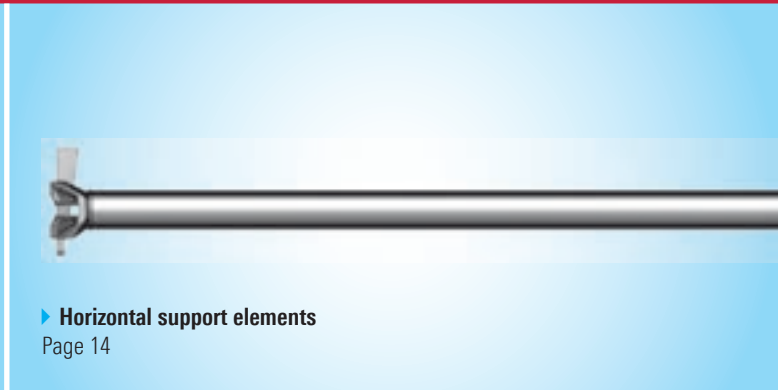

All dimensions and weights are guideline values. Subject to technical modification.

Steel parts are galvanized according to EN ISO 4042 and EN 12811-2.

Our deliveries shall be made exclusively in accordance with our currently valid General Terms of Sale. These include the following provisions: The place of performance is Gueglingen-Eibensbach. Title to the delivered goods shall be retained until full payment has been made.

Please request the specific instructions for assembly and use when ordering. Protected by copyright. Not to be reproduced, either in whole or in part. Misprints and errors excepted.

Detailed technical information can be found in our Allround technology brochure.



▶ **Scaffolding decks**
Page 22



▶ **Allround Shoring TG 60**
Page 36

CONTENTS

▶ ALLROUND STAR FRAME	8
▶ VERTICAL SUPPORT ELEMENTS	10
▶ SCAFFOLDING BASE PLATES	12
▶ HEAVY-DUTY SUPPORT	14
▶ HORIZONTAL SUPPORT ELEMENTS	14
▶ DIAGONAL BRACING	20
▶ SCAFFOLDING DECKS, ACCESS DECKS	22
▶ BRACKETS	30
▶ LATTICE BEAMS	32
▶ PEDESTRIAN PROTECTION, BRICK GUARD, SCAFFOLDING ENCLOSURE	32
▶ ALLROUND BRIDGING SYSTEM	34
▶ ALLROUND SHORING TG 60	36
▶ COMPACT STAIRWAY TOWER	36
▶ LANDING-TYPE STAIRWAY IN ALLROUND SCAFFOLDING	38
▶ MODULAR STAIRWAY, OUTSIDE ACCESS, CONSTRUCTION STAIRWAY TOWER 200	40
▶ STAIRWAY TOWERS 500 AND 750	42
▶ STAIRWAY STRINGERS AND GUARDRAILS	44
▶ COUPLERS	44
▶ SPARE PARTS, ANCHORING	44
▶ FLAT ROOF SIDE PROTECTION	46
▶ FALL PROTECTION	46
▶ SAFETY GEAR	48
▶ RAILING CLAMP	48
▶ SOFTWARE FOR SCAFFOLDING CONSTRUCTION	50

LAYHER ALLROUND SCAFFOLDING SYSTEM®



Allround scaffolding uses a simple, unique and bolt-free connection technology.

Sliding the wedge head over the rosette and inserting the wedge into the opening immediately secures the component. There is still sufficient play to secure the other end of the ledger.



A hammer blow to the wedge transforms the loose connection into a superbly strong structurally rigid one. The face of the wedge head is now precisely positioned against the standard.



The result of superior design.

Up to 8 connections can be made in the structurally ideal Allround connector on one level and at various angles. Connections are provided in standard dimensions of 50 cm on all Allround standards. The flat rosette prevents clogging with dirt of whatever type.



Ingenious connection technology.

The four small punched-out openings in the rosette automatically centre the ledger at right angles – the four large openings allow the angle of alignment to be selected.

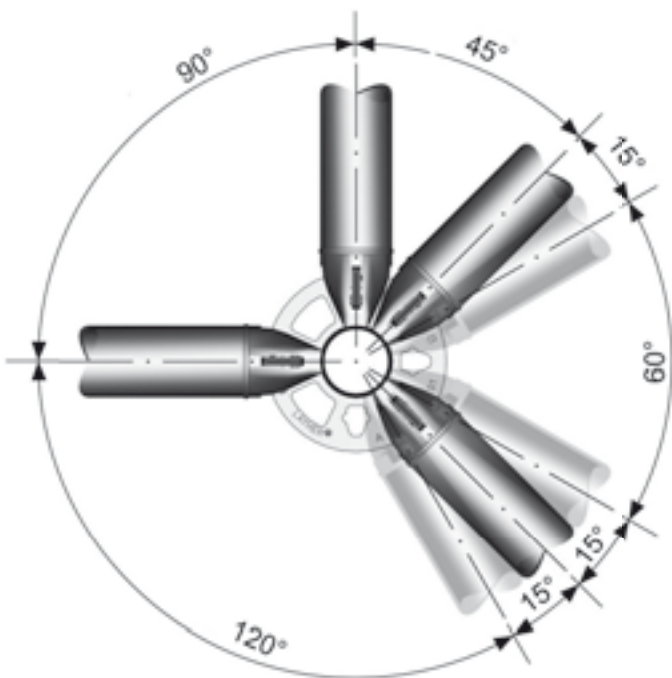

Strong and inexpensive (hot-dip galvanised) steel Allround scaffolding is primarily used for elaborate and ambitious scaffolding.

The advantage of the aluminium Allround scaffolding, which is identical in design, is its low weight and its suitability for applications where appearance is relevant or where steel is not permitted.

Minimal weight yet high and ideal transfer of force.

The wedge head and standard are matched to ensure central loading.

Approvals: Allround steel scaffolding Z-8.22-64 based on EN 12811.

Allround aluminium scaffolding Z-8.22-64.1.

Further international certifications available

World-leading technology for safety and reduced costs in ambitious scaffolding construction.

The only modular scaffolding with two general building authority approvals:

Steel: Modular system Z-8.22-64, this contains the approval for the connector and a regular version for work and protective scaffolding at the facade. Furthermore for the aluminium Allround connector Z-8.22-64.1 and the Allround U-STAR frame 70 Z-8.1-919.

Modular scaffolding technology began with Allround Scaffolding, and to this day this system is a byword for reliable scaffolding technology, allround application and fast, safe assembly on all construction sites. The ingenious connection technology based on the wedge-head principle, the rosette has central node point loading and preset, self-centering, right-angled bay assembly with at the same time variable scaffolding layout for birdcage scaffolding and special structures, rapid bolt-free assembly which is precision fitting and recognised by experts to be the basis for safe, quick and profitable scaffolding construction.

Reliable production and delivery readiness (made in Gueglingen-Eibensbach). An unequalled close-knit network of factory and international branches and customer service centres. Providing on-site advice and assistance in all matters relating to scaffolding.

The relevant regulations and the generally accepted rules of technology must be complied with.

There are in particular

- ▶ the building authority approvals,
- ▶ DIN EN 12810/12811 and DIN 4420
- ▶ German operating safety regulations with TRBS 2121 and BGI 5101,
- ▶ BGV C22 ("Building Work" accident prevention regulations), BGI 663 and other regulations.

Verification of stability:

If steel and aluminium components are used together, only the specified values for the aluminium version for connection load-bearing capacity and connection rigidity may be used to assess stability.

Reliable Allround technology is available for all main areas of application:

▶ **As original Layher Allround Scaffolding**

for professional scaffolding construction, quick all-round use on all construction sites.

▶ **As original Layher AluAllround**

the "lightweight" version for profitable applications, where it is important for the scaffolding structure to have a low dead weight, and in the construction of rolling towers and in stage, scenery and trade fair construction.

▶ **Also as original Layher Metric**

the dimensional alternative for stand construction and events, but also for use with existing scaffolding and scaffolding decks with metric dimensions.

Every item of original Layher Allround Scaffolding gives you the reassuring safety and security of a reliable partner:

▶ **Certified quality**

exceptionally precise production standards and consistent quality internationally certified to ISO 9001:2008 and assured by stringent quality guide-lines and the use of cutting-edge automatic welding machines. Hot-dip galvanized parts for long service life.

Ask for our Catalogue for *Construction Accessories*.



Allround STAR Frame

The great advantage of the new **STAR Frame** is its unrestricted integration into the existing Allround module system.

That means:

- ▶ Only one system for both façade and industrial scaffolding.
- ▶ Rapid assembly and new possibilities for using the Allround equipment.
- ▶ Use of the STAR Frame in conjunction with basic components of the Allround equipment.



Perfect compatibility with the Allround system

Revolutionary, the new guardrail attachment – rapid assembly without tools and increased safety thanks to rapid recognition of the closed state thanks to the red bar.







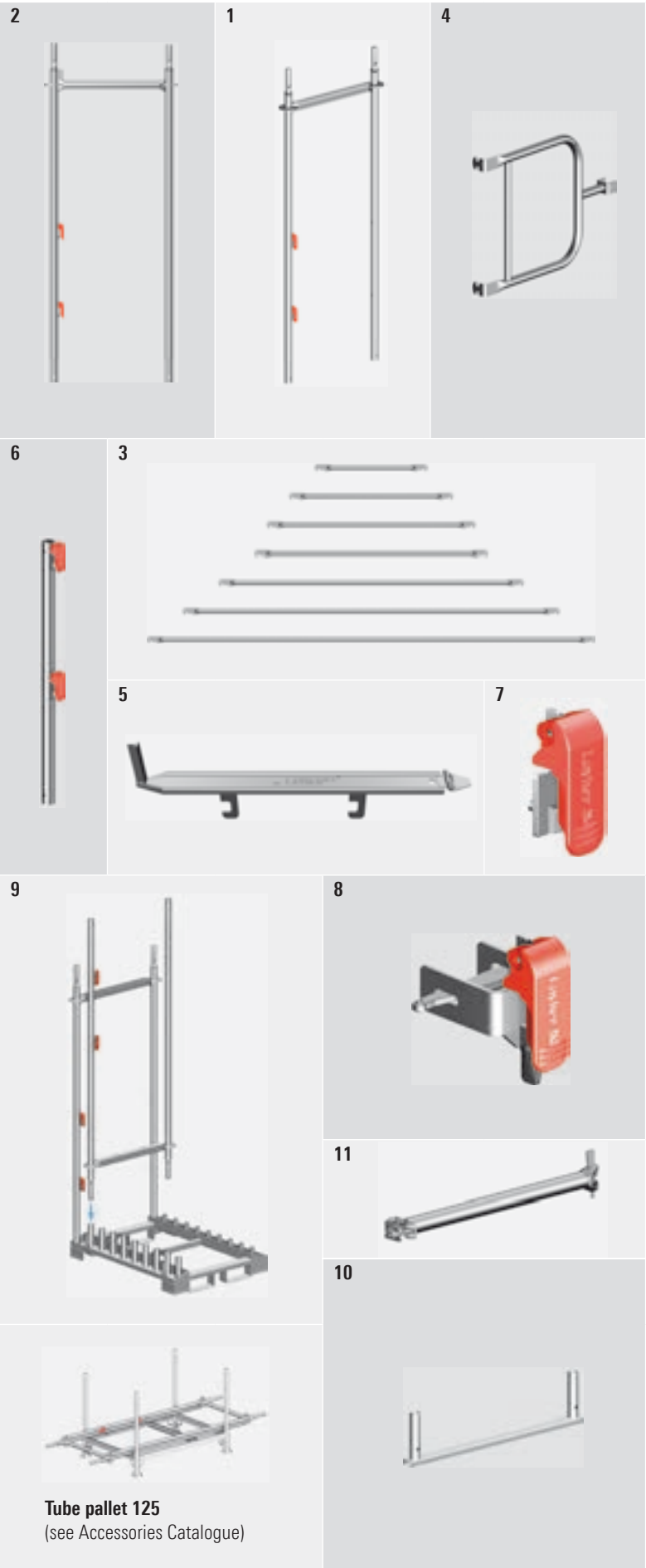









Layher 

More Possibilities. The Scaffolding System.

Allround STAR Frame



Tube pallet 125
(see Accessories Catalogue)

Pos.	Description	Dimensions L/H x W [m]	Weight approx. [kg]	PU [pcs.]	Ref. No.
1	U-STAR frame	2.0 x 0.73	18.0	22	2602.001 
2	O-STAR frame	2.0 x 0.73	16.5	22	2602.002 
3	STAR guardrail lightweight guardrail made of 33.7 mm tube. Assembly without tools ensures rapid installation and removal.	0.73	1.4	140	2602.005 
		1.09	2.0	140	2602.006 
		1.40	2.6	140	2602.007 
		1.57	2.9	140	2602.008 
		2.07	3.7	140	2602.009 
		2.57	4.5	140	2602.010 
		3.07	5.5	140	2602.011 
4	STAR double end guardrail closure of the scaffolding at its end. This permits the use of internal guardrails up to the end.	0.73	4.3	80	2602.014 
5	STAR lift-off preventer The welded-on toe board pin requires the use of the lift-off preventer before the toe boards as specified can be installed at the working levels. (only necessary for STAR U-frame)	0.73	1.4	150	2602.015 
6	STAR guardrail support top scaffolding closure of STAR type	1.0	4.7	50	2602.013 
7	STAR internal guardrail fixing device rapid tool-less assembly by swinging in the bar, for the connection of internal guardrails		0.3	160	2602.012 
8	STAR guardrail adaptor for lateral guardrail connection of STAR and Allround system		0.3	100	2602.016 
9	STAR pallet , without parts 19 STAR frames loading capacity with vertical storage and transport in the STAR pallet	1.2 x 0.91	42.3	10	5113.001 
10	STAR transport safeguard prevents the STAR frames from being pulled together on the truck when being secured. This ensures safe transportation. The top frame is secured with pins.	0.8	2.4	200	6309.001 
11	STAR O-ledger with half-coupler end guardrail in prepositioned platform access bay	19 WS 0.73	3.5	200	2607.074 

Vertical support elements of steel and aluminium

Standards are available in hot-dip galvanized steel tubing, dia. 48.3 x 3.2 mm, and aluminium tubing, dia. 48.3 x 4.0 mm, with rosettes at every 50 cm for a maximum of eight connections.

Four small openings in the rosette determine right-angled connections, four larger openings permit connections at any angles.



When used as suspended scaffolding or when moved with a crane, only the **Standard, steel, without spigot**, Ref. No. 2604, in conjunction with the **Spigot**, Ref. No. 2605.000, or **Standard, aluminium, without spigot** Ref. No. 3208 with the **Spigot**, Ref. No. 3209.000, may be used. To connect the individual suspended scaffolding standards, either **Hinged pins**, Ref. No. 4905.666 or **Special bolts M12 x 60 with nut**, Ref. No. 4905.060 can be used. However the spigots should always be bolted in the standard with the special bolts.

The **Rosette, clampable**, Ref. No. 2602, can be connected to any point on the standard – tightening torque 50 Nm – and allows up to six ledgers or diagonal braces to be connected to it. This permits flexible solutions between the rosettes even when connected to SpeedyScaf. Loading table available on request.

The **Base collar**, Ref. No. 2602.000, with rosette and the height-adjustable base plate form the scaffolding base. The vertical standard is placed into the base collar for further construction.

The **Base collar, long**, Ref. No. 2660.000, is required with aluminium Allround standards. For Allround rolling towers it facilitates a correct securing of the castors with locks against falling out.

The **Standard lock 0.5 m** can be used to bridge standard joints, for example when moving scaffolding using a crane or for suspended scaffolding. Permissible load capacity: 18.8 kN.

Layher 

More Possibilities. The Scaffolding System.

Vertical support elements of steel and aluminium

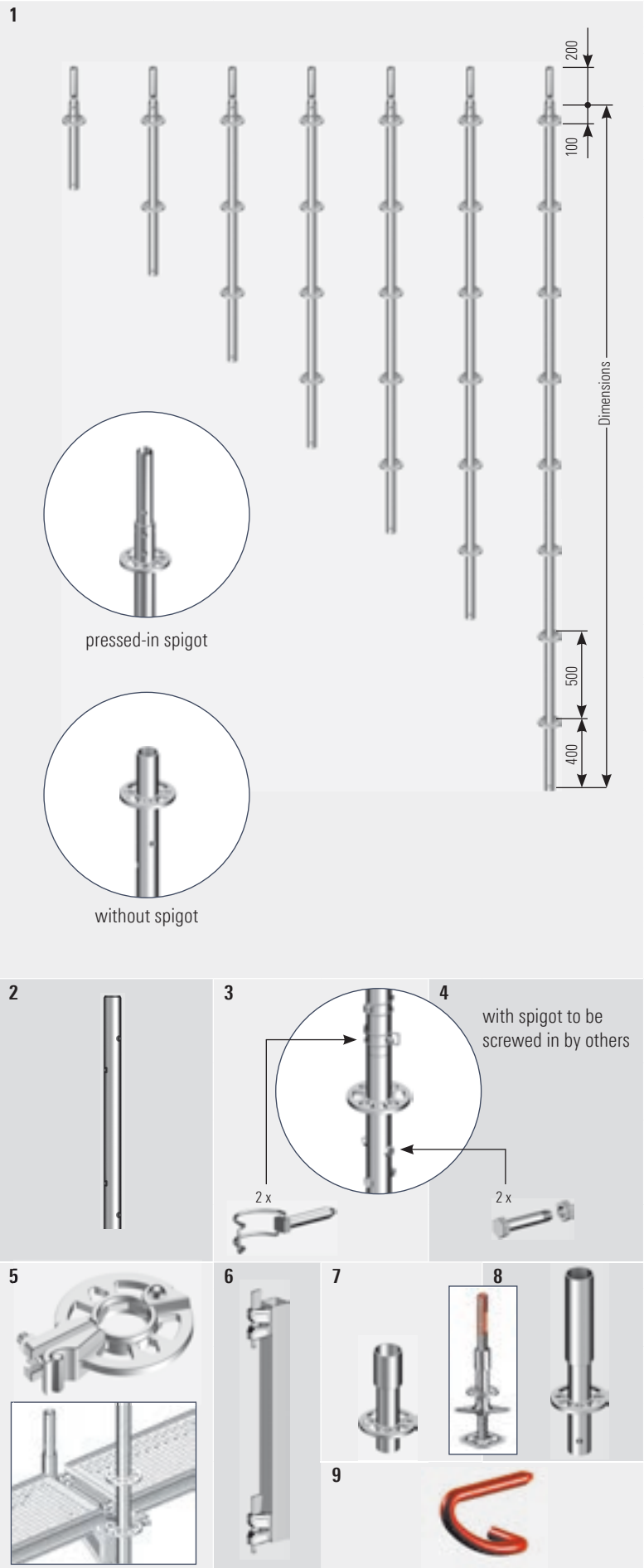

Pos.	Description	Dimensions L/H x W [m]	Weight approx. [kg]	PU [pcs.]	Ref. No.
1	Standard , steel, with pressed-in spigot	0.5	3.2	240	5603.050
		1.0	5.5	28	2603.100
		1.5	7.8	28	2603.150
		2.0	10.2	28	2603.200
		2.5	12.2	28	2603.250
		3.0	14.6	28	2603.300
		4.0	19.1	28	2603.400
	Initial standard with pressed-in spigot for use in the lowest scaffolding level without base collar or for assembly of the modular scaffolding stairway tower.	2.21	11.4	28	2603.221
	Standard , steel, without spigot e.g. for receiving head jacks, or for suspended scaffolding use the spigot Ref. No. 2605.000	0.5	2.5	300	2604.050
		1.0	4.6	28	2604.100
		1.5	6.8	28	2604.150
		2.0	9.0	28	2604.200
		2.5	11.7	28	2604.250
		3.0	13.7	28	2604.300
		4.0	18.1	28	2604.400
	Standard , aluminium, with pressed-in spigot	1.0	2.2	28	3200.100
		1.5	3.2	28	3200.150
		2.0	4.1	28	3200.200
		2.5	5.0	28	3200.250
		3.0	5.9	28	3200.300
		4.0	7.7	28	3200.400
	Standard , aluminium, without spigot for suspended scaffolding	1.0	1.9	28	3209.100
		1.5	2.8	28	3209.150
		2.0	3.8	28	3209.200
		2.5	4.7	28	3209.250
		3.0	5.6	28	3209.300
		4.0	7.5	28	3209.400
2	Spigot for Ref. No. 2604, steel	0.52	1.6	350	2605.000
	for Ref. No. 3209, aluminium	0.52	0.8	200	3209.000
3	Hinged pin , dia. 12 mm with pan-head		0.1	20	4905.666
4	Special bolt M12 x 60 , with nut		0.1	50	4905.060
5	Rosette , clampable	19 WS	0.12	1.0	2602.019
		22 WS	0.12	1.0	25
6	Standard lock , 0.5 m	0.58	4.0		2603.000
7	Base collar	0.24	1.4	500	2602.000
8	Base collar , long	0.43	2.2	400	2660.000
9	Locking pin , red, dia. 11 mm		0.2	200	4000.001

Scaffolding base plates

To adjust to the ground, choose between different height-adjustable **Base plates** with sturdy and self-cleaning round threads, with colour and notch markings to provide protection against overwinding. Make sure that there are sufficient load-distributing surfaces. For all inclined erection surfaces, e.g. in combustion chambers or ship hulls, **Swivelling base plates 60, reinforced** are used.

The round threads of all Layher scaffolding spindles have an outside diameter of 38 mm and a pitch of 8.1 mm. The wing external dimension of the spindle nut is 205 mm. The dimensions of the foot plate are 150 x 150 mm.

Base plate (normal) $\hat{=}$ 4.5 mm wall thickness
 Base plate (reinforced) $\hat{=}$ 6.3 mm wall thickness
 Base plate/head jack solid $\hat{=}$ solid material

Load capabilities of spindle cross-section as per DIN EN 12811-1

Spindle type	Npl,d [kN]	Mpl,d [kNm]	Vpl,d [kN]
normal	97.7	83.0	36.0
reinforced	119.9	94.5	44.1
solid	288.0	157.0	106.0

The **Spindle fixture with wedge-head** serves to secure the base plate and the base collar against falling out when moving scaffolding with a crane.







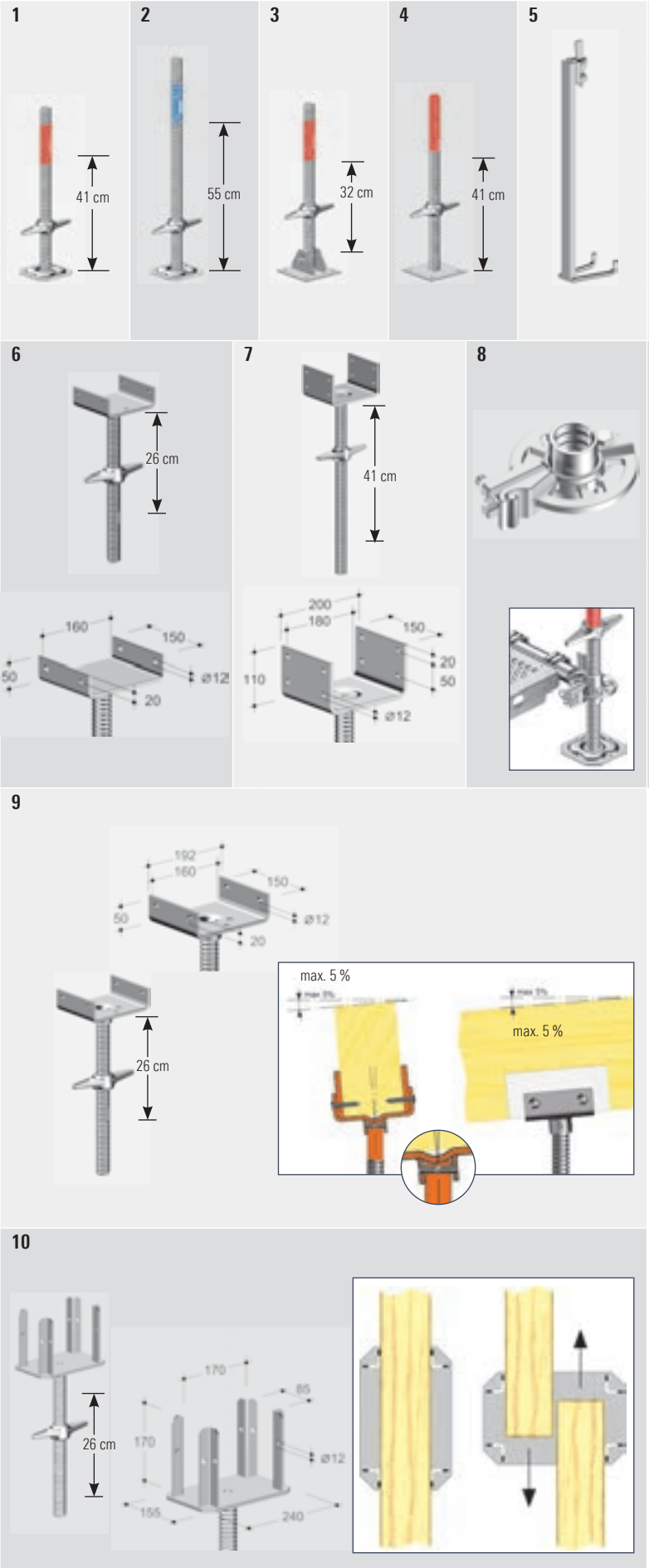

The **Head jack** accommodates wood sections or steel beams and serves to adjust height and introduce loads. The solid head jacks and base plates can be recognized by the hexagonal opening provided in them.

The **Swivelling top spindle** can be used to install supports (e.g. wood sections) with an inclination of up to max. 5% to the horizontal in the longitudinal and transversal directions, thus eliminating the need to level with a wedge. Greater loads can be supported thanks to the articulated mounting of the top plate and the resulting centric introduction of vertical forces into the spindles.

The **Cross head jack 45, solid** serves to accommodate wood sections, glued binders or steel beams in falsework and supporting scaffolding. It stabilizes the supports against tilting, and it is possible to use one or two formwork supports. Height adjustment is performed using the spindle nut. The cross head jack is suitable for all common formwork supports.

Scaffolding base plates



Pos.	Description	Dimensions L/H x W [m]	Weight approx. [kg]	PU [pcs.]	Ref. No.	
1	Base plate 60 (max. spindle travel 41 cm)	0.6	3.6	200	4001.060	
2	Base plate 80 , reinforced (max. spindle travel 55 cm)	0.8	4.9	200	4002.080	
3	Swivelling base plate 60 , reinforced (max. spindle travel 32 cm), ensure sufficient structural strength	0.6	6.1	250	4003.000	
4	Base plate 60 , solid, without lock (max. spindle travel 41 cm)	0.6	6.7	200	5602.060 	
5	Spindle attachment with wedge-head	0.6	2.0	150	2602.100 	
6	Head jack 45 , solid, 16 cm (max. spindle travel 26 cm), width of fork 16 cm, height of fork 5 cm	0.45	6.6	50	5314.045 	
7	Head jack 60 , reinforced, 18 cm (max. spindle travel 41 cm), width of fork 18 cm, height of fork 10 cm	0.6	8.0	100	5316.060 	
8	Rosette with thread , clampable	19 WS	0.12	1.7	100	2602.119 
		22 WS	0.12	1.7	100	2602.122 
9	Swivelling head jack 45 , solid (max. spindle travel 26 cm), effective width of fork 16 cm	0.45	7.3	50	5312.045 	
10	Cross head jack 45 , solid (max. spindle travel 26 cm), opening dimensions 8.5 / 17 cm	0.45	6.9	50	5315.045 	

Ask for our *Catalogue for Construction Accessories and Versatile System Parts*.



The **Rosette with thread, clampable** can be attached to the thread of the Layher base plate or head jack. This rosette can be used, when the spindle nut is undone, for bracing in the longitudinal, transverse and diagonal directions. Up to six connections are possible.

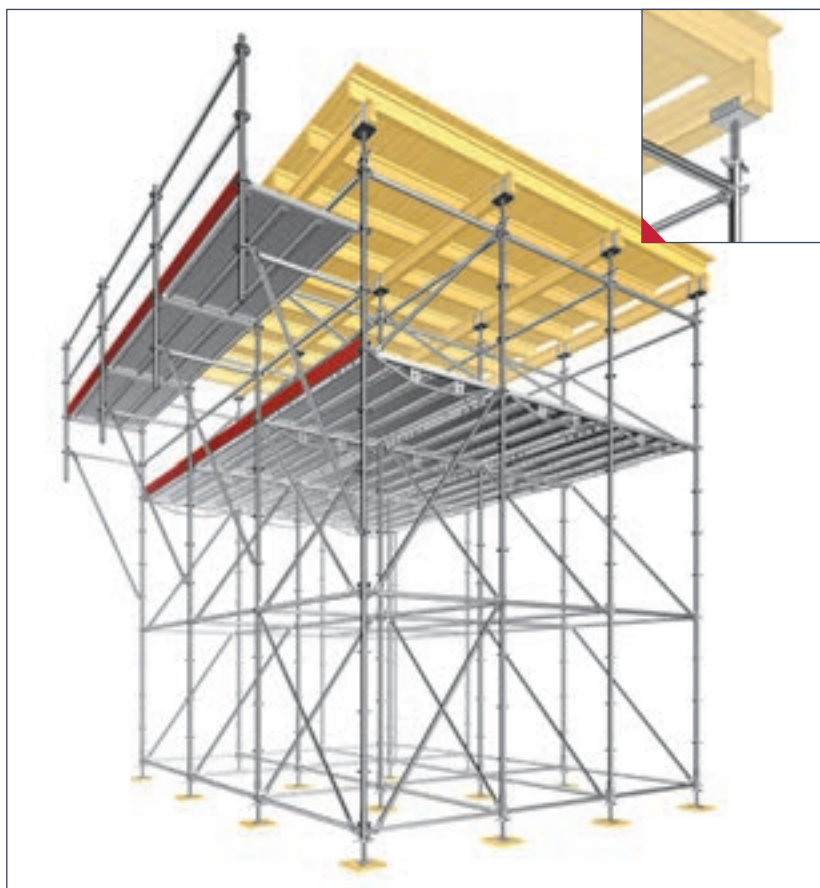

Spindle attachment with wedge-head

WS = wrench size PU = packaging unit  = available ex works  = delivery time on request  = only available in this packaging unit

Heavy-duty support

An extremely high load-bearing capacity is achieved by combining four Allround standards. Specially developed top and base pieces, and heavy-duty spindles fitted into the latter, permit a multiplication of the individual load capacities of each standard.

A support of this type can be used
as a **single support (20 t)**
as a **double support (40 t)**
or as a **tower (67 t)**.

These individual elements can then be expanded, with the aid of further Allround standard elements, into any spatial structures required.

Using the **Single open-end wrench, WS 95**, both the base plate and the head jack can be levelled during assembly. During dismantling, spindle lowering – for example when removing formwork – is possible without any problems.

Heavy-duty support

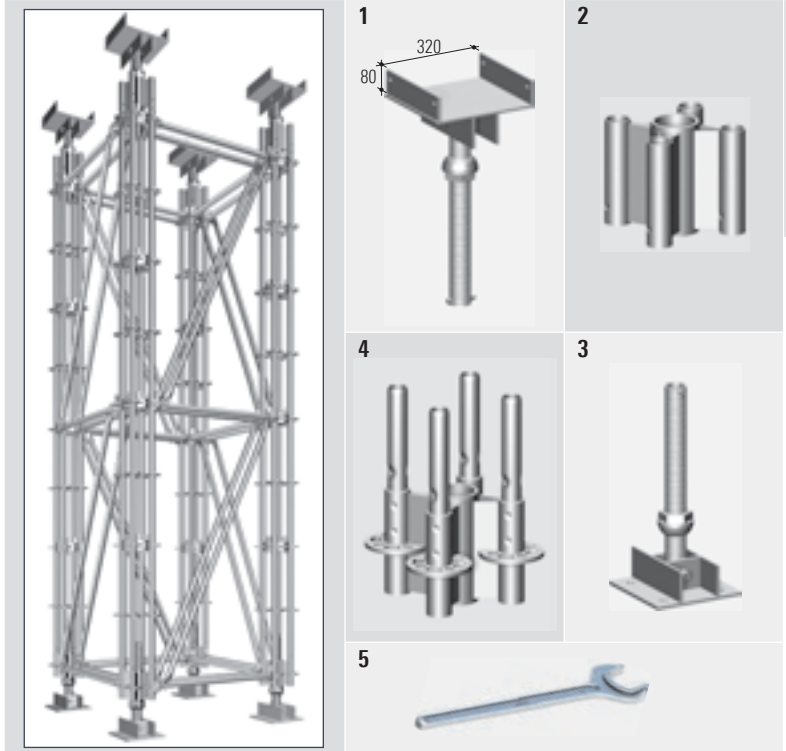

Horizontal support elements, side protection

Depending on the scaffolding bay length, deck type and load, **Ledgers** made of steel or aluminium are available in cylindrical tube, U-section and reinforcement sections for higher loads. The ledgers are deck beams, bracing elements and guardrails.

The wedge lock connection ensures positive and non-positive connection with central load introduction between standards and ledgers. Safety is already assured in the assembly state because the wedge lock already prevents unintentional disengagement when the wedge is loosely inserted. Longitudinal ledgers can be omitted at deck level if the decks are secured against lifting off by a lift-off preventer.

Load capacity of O-ledger, steel *							
Ledger length (system dimension) [m]	0,73	1,09	1,40	1,57	2,07	2,57	3,07
Evenly distributed line load q [kN/m]	22,07	10,44	6,54	5,26	3,12	2,06	1,46
Individual load P in centre of bay [kN]	7,43	5,21	4,17	3,77	2,96	2,42	2,06

* Working load

Horizontal support elements, side protection

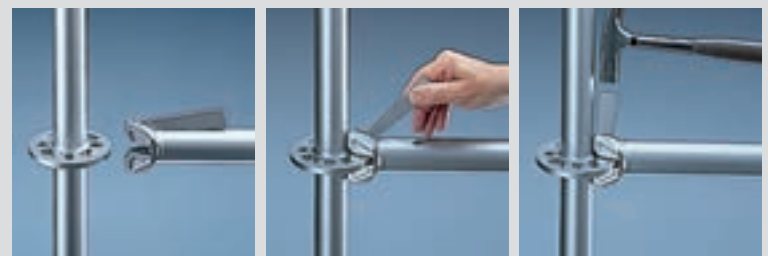

Slide the wedge-head over the rosette.

Insert the wedge into a hole. The component is secure against shifting and falling out.

Hammer down the wedge to provide a non-positive connection (use 500 g metal hammer until the blow bounces off).



Layher 

More Possibilities. The Scaffolding System.

Pos.	Description	Dimensions L/H x W [m]	Weight approx. [kg]	PU [pcs.]	Ref. No.
1	Head jack for heavy-duty support	0.7	30.9		5312.004
2	Head part for heavy-duty support	0.21	7.1		5312.003
3	Base plate for heavy-duty support	0.7	24.1		5312.001
4	Base piece for heavy-duty support	0.4	11.5		5312.002
5	Single open-end wrench, WS 95	0.6	7.0		5312.005

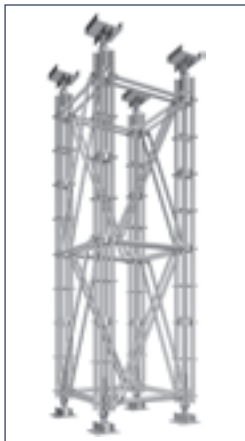

Heavy-duty support as tower with a total load-bearing approx.acity of 67 t.

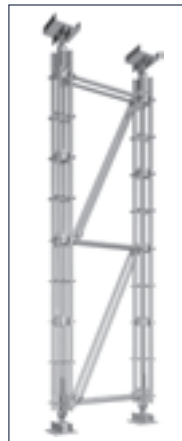

Heavy-duty support as double support with a total load-bearing approx.acity of 40 t.

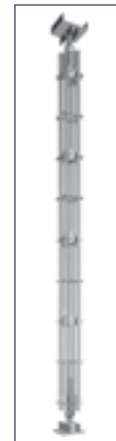

Single heavy-duty support with a load-bearing approx. acity of 20 t.

Pos.	Description	Dimensions L/H x W [m]	Weight approx. [kg]	PU [pcs.]	Ref. No.	
6	O-ledger, steel The 0.39 m ledger is used on the 0.39 m bracket for fall protection at the end. The 1.04 m ledger corresponds to half the 2.07 m bay. The 1.29 m ledger corresponds to half the 2.57 m bay. The ledger 0.90 m is used for construction of the equalising modular stairway.	0.39	1.8	250	2607.039	
		0.45	2.4	250	2607.045	
		0.73	3.1	400	2607.073	
		0.90	3.9	50	2607.090	
		1.04	4.4	50	2607.103	
		1.09	4.3	50	2607.109	
		1.29	5.3	50	2607.129	
		1.40	5.4	50	2607.140	
		1.57	5.9	50	2607.157	
		2.07	7.8	50	2607.207	
		2.57	9.4	50	2607.257	
		3.07	11.4	50	2607.307	
		4.14	15.1	50	2607.414	
		O-ledger, aluminium	0.73	2.8	200	3201.073
			1.09	3.5	50	3201.109
			1.40	3.7	50	3201.140
1.57	4.0		50	3201.157		
2.07	4.5		50	3201.207		
2.57	4.9		50	3201.257		
3.07	5.5		50	3201.307		
7	O-ledger, steel, Metric	0.25	1.6	700	2607.025	
		0.50	2.5	700	2607.050	
		1.00	4.3	50	2607.100	
		1.50	5.8	50	2607.150	
		2.00	7.5	50	2607.200	
		2.50	9.7	50	2607.250	
		3.00	10.9	50	2607.300	
8	O-ledger, steel, reinforced	1.09	5.9	50	2611.109	

Horizontal support elements, side protection

U-ledger deck configuration

0.45 m	1 x 0.32 m
0.50 m	2 x 0.19 m
0.73 m	2 x 0.32 m or 1 x 0.61 m
1.09 m	3 x 0.32 m or 1 x 0.61 m + 1 x 0.32 m
1.40 m	4 x 0.32 m or 2 x 0.61 m
1.57 m	4 x 0.32 m and 1 x 0.19 m
2.07 m	6 x 0.32 m
2.57 m	7 x 0.32 m and 1 x 0.19 m
3.07 m	9 x 0.32 m

Loading capacity of U-ledger, U- and O-ledger, steel, reinforced*

Ledger type and length [m]	U 0.73	U – V 1.09	U – V 1.40	O – V 1.09	O – V 1.29
Evenly distributed line load q [kN/m]	19.01	17.34	10.42	21.82	15.56
Individual load P in bay centre [kN]	6.10	8.76	6.84	11.00	9.34

Loading capacity of U- and O-bridging ledger, steel*

Ledger type [m]		1.57	2.07	2.57	3.07
Evenly distributed line load q [kN/m]	O	14.46	8.63	5.37	3.53
	U	15.16	8.65	5.12	3.59
Individual load P in bay centre [kN]	O	10.60	6.88	4.64	3.57
	U	7.97	6.92	5.25	5.24

* Working load

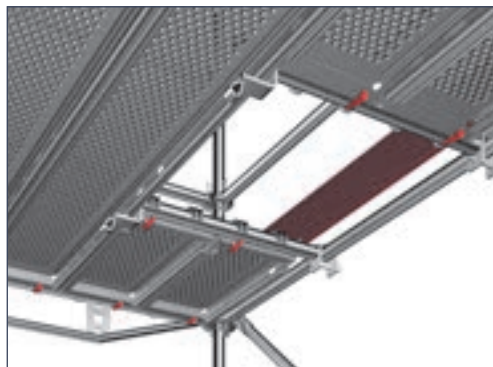
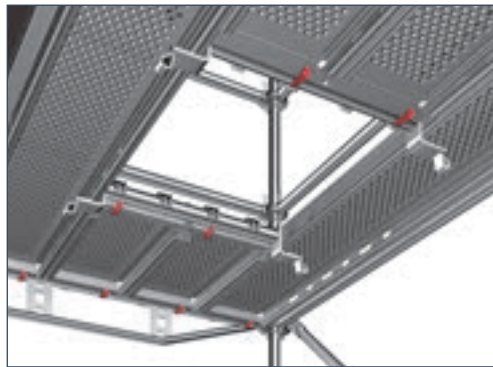

Horizontal support elements, side protection

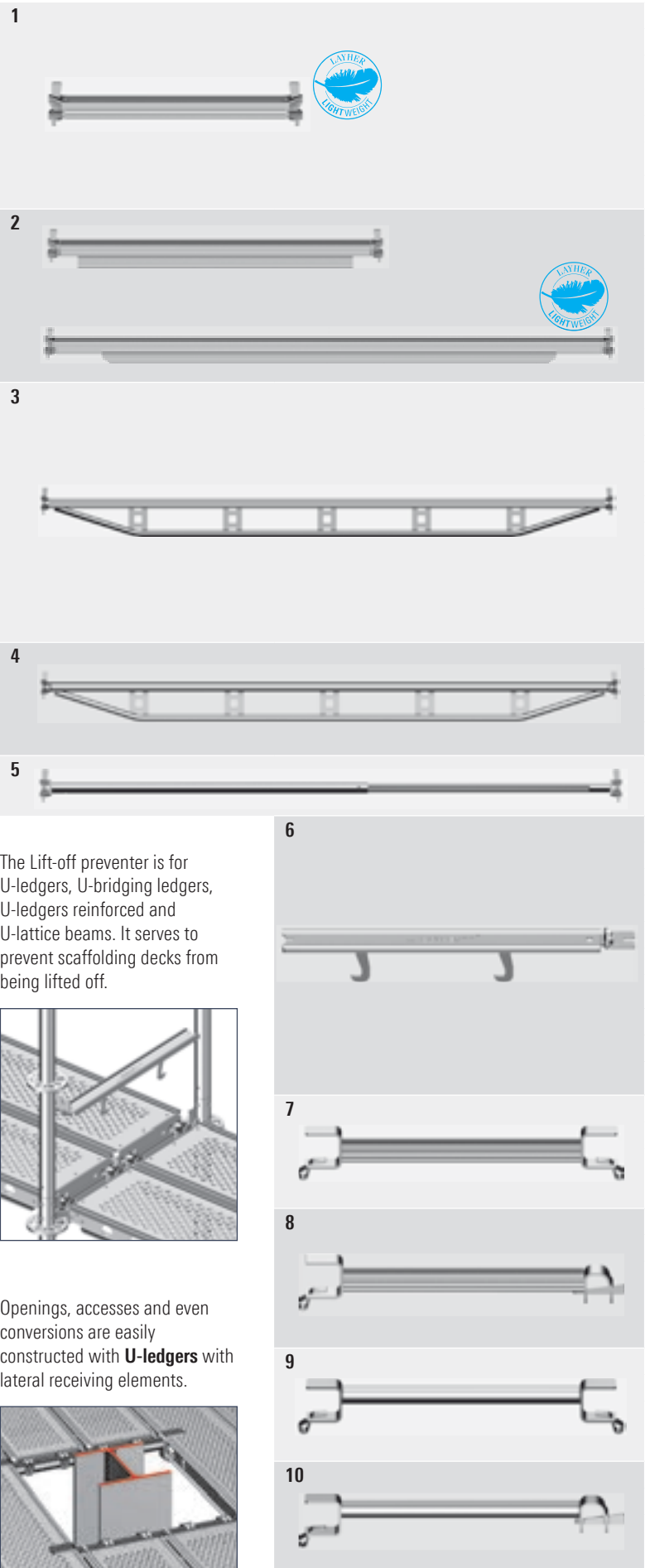

The Lift-off preventer is for U-ledgers, U-bridging ledgers, U-ledgers reinforced and U-lattice beams. It serves to prevent scaffolding decks from being lifted off.

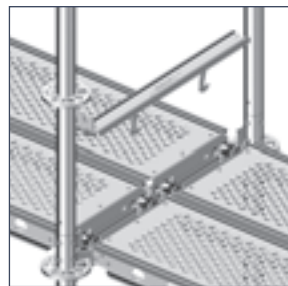



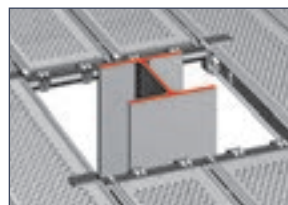































Openings, accesses and even conversions are easily constructed with **U-ledgers** with lateral receiving elements.



Layher 

More Possibilities. The Scaffolding System.

Pos.	Description	Dimensions L/H x W [m]	Weight approx. [kg]	PU [pcs.]	Ref. No.	
1	U-ledger, steel	0.45	2.1	250	2613.045	
		0.50	2.5	250	2613.050 	
		0.73	3.1	400	2613.073	
	U-ledger, LW		1.00	4.1	50	2613.100 
			1.09	4.4	50	2613.108
			1.40	5.4	50	2613.139 
			U-ledger, aluminium	0.73	1.5	200
2	U-ledger, aluminium, reinforced	1.09	3.7	50	3203.109 	
		1.40	4.5	50	3203.140 	
	U-ledger, steel, reinforced LW		1.57	9.4	50	2613.157
			2.07	12.7	50	2613.207
			2.57	15.7	50	2613.257
			3.07	18.5	50	2613.307 
			U-bridging ledger, steel	1.57	9.4	50
U-bridging ledger, aluminium	1.57	4.3	20	3207.157 		
	2.07	5.5	20	3207.207 		
3	U-bridging ledger, steel, Metric	2.00	12.2	50	2624.200 	
		2.50	15.0	50	2624.250 	
		3.00	17.9	50	2624.300 	
		O-bridging ledger, steel	1.57	9.7	50	2625.157 
	4		2.07	12.6	50	2625.207 
2.57			15.8	50	2625.257 	
3.07			19.2	50	2625.307 	
5			Guardrail, adjustable for use in compensation bays	1.57 – 2.57	8.5	50
	1.09 – 1.57	5.7		50	2606.001 	
6	Lift-off preventer T8	0.39	0.6	250	2635.039 	
		0.45	0.7	250	2635.045 	
		0.73	1.3	250	2635.073	
		1.00	1.7	50	2635.100 	
		1.09	1.8	50	2635.109	
		1.40	2.5	50	2635.140 	
		1.57	3.0	50	2635.157 	
	Lift-off preventer T9	2.07	7.9	50	2658.207	
		2.57	9.9	50	2658.257	
		3.07	11.9	50	2658.307	
7	U-ledger steel deck – steel deck, for connection on both sides to the steel deck flank, with securing flaps, loadable up to load class 3, up to steel decks of 3.07 m	0.32	3.1	100	2614.030 	
		0.64	4.3	50	2614.073 	
		0.96	5.5	50	2614.108 	
8	U-ledger steel deck – O-ledger, one side for connection to the steel deck flank, with securing flap, the other side for connection to an O-ledger, with securing wedge	0.32	3.3	100	2614.001 	
		0.64	4.4	50	2614.002 	
		0.96	6.5	50	2614.004 	
9	O-ledger steel deck – steel deck, for connection on both sides to the steel deck flank, with securing flaps, loadable up to load class 3, up to steel decks of 3.07 m	0.32	3.1	100	2614.069 	
		0.70	4.2	50	2614.070 	
		1.09	5.2	50	2614.071 	
10	O-ledger steel deck – O-ledger, one side for connection to the steel deck flank, with securing flap, the other side for connection to an O-ledger, with securing wedge	0.32	2.4	100	2614.032 	
		0.64	4.4	50	2614.064 	
		0.96	5.5	50	2614.096 	

Horizontal support elements, side protection

The **O-board bearer** is used to provide trip-proof decking surfaces with boards. For use of scaffolding boards see DIN 4420. Accesses with O-decks can also be provided.

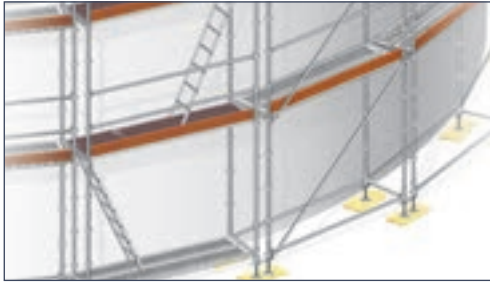

The **U-ledger 0.73 m, 15° – 44°, WS 19** permits low angles in large circular scaffolding structures.

The three-part side protection in the scaffolding bay and at the ends of the scaffolding is completed with **Toe boards**. The fitting is positioned between vertical standard and wedge.

The **O-/U-steel toe board** reduces the fire risk. The offset fittings permit a gap-free transition from the deck to the toe board. It features high stiffness and is easy to stack.

The **O-/U-toe board, aluminium** is the lightweight alternative and can also be used in the case of special fire protection requirements.

The three-part side protection comprises **Toe board**, **Ledger** as intermediate rail (knee rail) and **Ledger** as hand rail.

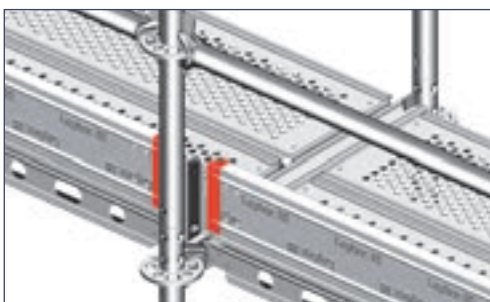

Individual toe boards

Use your scaffolding as advertising space:
The toe boards can if required be custom-designed in colour and print.

Horizontal support elements, side protection

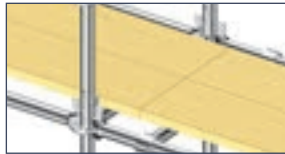

The lift-off prevention of the planks is provided by customer.



1



2

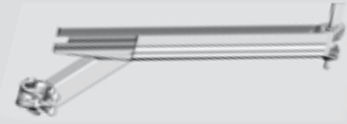

3



4

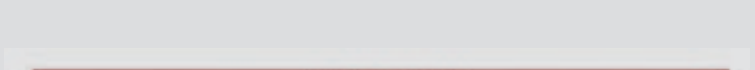

5

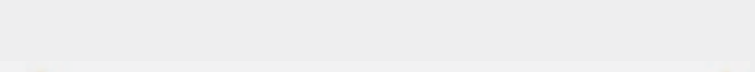

6



Advantages:

- ▶ Reduction of fire risk
- ▶ High stiffness and sturdiness
- ▶ Easy stacking of the toe boards
- ▶ No gap between toe board and deck

7

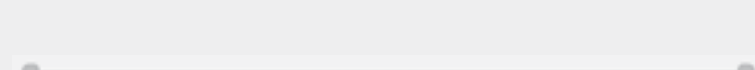

8

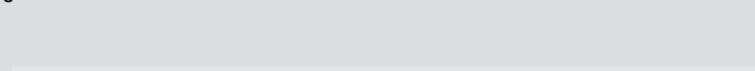

9

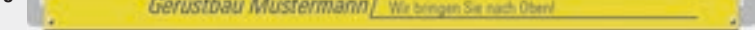

Layher 

More Possibilities. The Scaffolding System.

Pos.	Description	Dimensions L/H x W [m]	Weight approx. [kg]	PU [pcs.]	Ref. No.
1	O-board bearer steel	0.73	3.5	50	2615.073
		1.09	4.6	50	2615.109
		1.40	6.7	50	2615.140
		1.57	7.4	50	2615.157
		2.07	10.3	50	2615.207
		2.57	12.5	50	2615.257
		3.07	15.0	50	2615.307
2	U-ledger , 0.73 m, 15° – 44°, WS 19	0.73	3.6		2611.073
3	U-toe board , wood for decks with U-insertion, for longitudinal and end sides	0.73 x 0.15	1.5	140	2640.073
		1.09 x 0.15	2.5	140	2640.109
		1.40 x 0.15	3.5	140	2640.140
		1.57 x 0.15	3.5	140	2640.157
		2.07 x 0.15	4.6	140	2640.207
		2.57 x 0.15	5.7	140	2640.257
		3.07 x 0.15	7.1	140	2640.307
	4.14 x 0.15	7.5	140	2640.414	
4	O-toe board , wood for decks with O-insertion, for longitudinal and end sides	0.73 x 0.15	1.5	140	2642.073
		1.09 x 0.15	2.5	140	2642.109
		1.40 x 0.15	3.4	140	2642.140
		1.57 x 0.15	3.5	140	2642.157
		2.07 x 0.15	4.3	140	2642.207
		2.57 x 0.15	5.7	140	2642.257
		3.07 x 0.15	6.3	140	2642.307
5	U-steel toe board	0.73 x 0.15	1.8	280	2649.073
		1.09 x 0.15	2.5	140	2649.109
		1.40 x 0.15	3.1	140	2649.140
		1.57 x 0.15	3.4	140	2649.157
		2.07 x 0.15	4.4	140	2649.207
		2.57 x 0.15	5.4	140	2649.257
		3.07 x 0.15	6.3	140	2649.307
6	O-steel toe board	0.73 x 0.15	1.7	280	2648.073
		1.09 x 0.15	2.4	140	2648.109
		1.40 x 0.15	3.0	140	2648.140
		1.57 x 0.15	3.3	140	2648.157
		2.07 x 0.15	4.3	140	2648.207
		2.57 x 0.15	5.3	140	2648.257
		3.07 x 0.15	6.2	140	2648.307
7	U-toe board , aluminium for longitudinal and end sides, lightweight and durable	0.73 x 0.15	1.5	210	2651.073
		1.09 x 0.15	2.2	210	2651.109
		1.40 x 0.15	2.9	210	2651.140
		1.57 x 0.15	3.1	210	2651.157
		2.07 x 0.15	3.7	210	2651.207
		2.57 x 0.15	4.7	210	2651.257
		3.07 x 0.15	5.7	210	2651.307
8	O-toe board , aluminium for longitudinal and end sides, lightweight and durable	0.73 x 0.15	1.5	210	2641.073
		1.09 x 0.15	2.2	210	2641.109
		1.40 x 0.15	2.9	210	2641.140
		1.57 x 0.15	3.1	210	2641.157
		2.07 x 0.15	3.3	210	2641.207
		2.57 x 0.15	4.1	210	2641.257
		3.07 x 0.15	4.9	210	2641.307
9	Individual toe board design				on request

Diagonal bracing

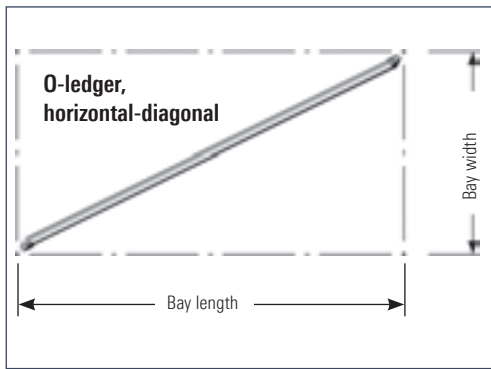

The **O-ledger, horizontal-diagonal**, with wedge-heads serves to brace horizontal levels in scaffolding without standard decks or in scaffolding with board decking.

The **Diagonal braces** with wedge locks further brace the basic system consisting of standards and ledgers, and thanks to their high connection values also facilitate special structures.

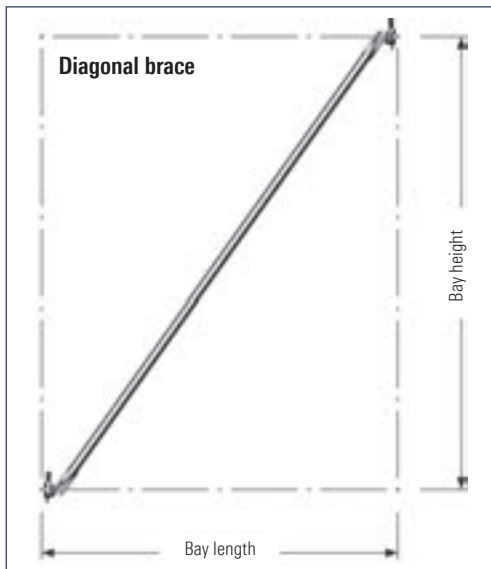

Diagonal bracing

2

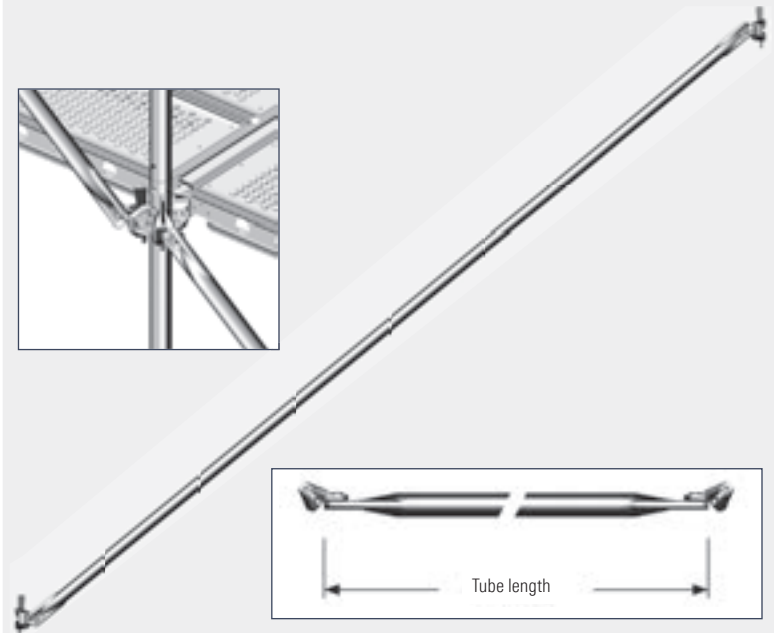

1

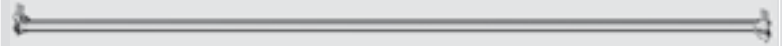

For rectangular floor plan, with offset welded wedge-heads.



For square floor plan, with straight welded wedge-heads.

Pos.	Description	Dimensions L/H x W [m]	Weight approx. [kg]	PU [pcs.]	Ref. No.
1	O-ledger, horizontal-diagonal, steel				
	for 1.09 m bay length, 1.09 m bay width	1.54	6.2	50	2608.108
	for 1.57 m bay length, 1.09 m bay width	1.94	6.9	50	2608.159
	for 1.57 m bay length, 1.57 m bay width	2.22	8.7	50	2608.157
	for 2.00 m bay length, 2.00 m bay width	2.83	11.3	50	2608.200
	for 2.07 m bay length, 0.73 m bay width	2.19	9.0	50	2608.208
	for 2.07 m bay length, 1.09 m bay width	2.34	9.3	50	2608.209
	for 2.07 m bay length, 2.07 m bay width	2.93	11.5	50	2608.207
	for 2.57 m bay length, 0.73 m bay width	2.67	10.8	50	2608.258
	for 2.57 m bay length, 1.09 m bay width	2.79	9.7	50	2608.259
	for 2.57 m bay length, 2.57 m bay width	3.64	14.0	50	2608.257
	for 3.07 m bay length, 0.73 m bay width	3.16	12.3	50	2608.308
	for 3.07 m bay length, 1.09 m bay width	3.26	11.0	50	2608.309
	for 3.07 m bay length, 3.07 m bay width	4.34	15.8	50	2608.307

Pos.	Description	Dimensions L/H x W [m]	Weight approx. [kg]	PU [pcs.]	Ref. No.	
2	Diagonal brace, steel					
	for 0.73 m bay length, 2.0 m bay height	2.12	6.8	50	2620.073	
	for 1.04 m bay length, 2.0 m bay height	2.23	7.6	50	2620.104	
	for 1.09 m bay length, 2.0 m bay height	2.25	7.0	50	2620.109	
	for 1.40 m bay length, 2.0 m bay height	2.40	7.5	50	2620.140	
	for 1.57 m bay length, 2.0 m bay height	2.49	7.7	50	2620.157	
	for 2.07 m bay length, 2.0 m bay height	2.81	8.9	50	2620.207	
	for 2.57 m bay length, 2.0 m bay height	3.18	9.5	50	2620.257	
	for 3.07 m bay length, 2.0 m bay height	3.58	10.5	50	2620.307	
	for 4.14 m bay length, 2.0 m bay height	4.51	14.0	50	2620.414	
	for 0.73 m bay length, 1.0 m bay height	1.20	4.2	50	2621.001	
	for 0.73 m bay length, 1.5 m bay height	1.65	5.4	50	2621.002	
	for 1.09 m bay length, 0.5 m bay height	1.10	4.0	50	2621.008	
	for 1.09 m bay length, 1.0 m bay height	1.41	4.8	50	2621.006	
	for 1.09 m bay length, 1.5 m bay height	1.81	5.8	50	2621.007	
	for 1.57 m bay length, 0.5 m bay height	1.55	5.7	50	5606.050	
	for 1.57 m bay length, 1.0 m bay height	1.79	6.3	50	5606.100	
	for 1.57 m bay length, 1.5 m bay height	2.11	7.3	50	5606.150	
	for 2.07 m bay length, 0.5 m bay height	2.03	7.2	50	5609.050	
	for 2.07 m bay length, 1.0 m bay height	2.20	7.4	50	5609.100	
	for 2.07 m bay length, 1.5 m bay height	2.48	8.2	50	5609.150	
	for 2.57 m bay length, 0.5 m bay height	2.51	8.4	50	5607.050	
	for 2.57 m bay length, 1.0 m bay height	2.66	8.8	50	5607.100	
	for 2.57 m bay length, 1.5 m bay height	2.89	9.5	50	5607.150	
	for 3.07 m bay length, 0.5 m bay height	3.00	9.6	50	5610.050	
	for 3.07 m bay length, 1.0 m bay height	3.13	9.9	50	5610.100	
	for 3.07 m bay length, 1.5 m bay height	3.32	10.5	50	5610.150	
	Diagonal brace, aluminium					
	for 0.73 m bay length, 2.0 m bay height	2.12	3.9	50	3204.073	
	for 1.09 m bay length, 2.0 m bay height	2.25	4.1	50	3204.109	
	for 1.40 m bay length, 2.0 m bay height	2.40	4.2	50	3204.140	
	for 1.57 m bay length, 2.0 m bay height	2.49	4.3	50	3204.157	
	for 2.07 m bay length, 2.0 m bay height	2.81	4.7	50	3204.207	
	for 2.57 m bay length, 2.0 m bay height	3.18	4.9	50	3204.257	
	for 3.07 m bay length, 2.0 m bay height	3.58	5.3	50	3204.307	
	Diagonal brace, steel, Metric					
	for 2.00 m bay length, 2.0 m bay height	2.76	8.8	50	2620.200	
	for 2.50 m bay length, 2.0 m bay height	3.12	10.0	50	2620.250	
	for 3.00 m bay length, 2.0 m bay height	3.52	11.2	50	2620.300	
	for 1.00 m bay length, 0.5 m bay height	1.03	3.8	50	2621.003	
	for 1.00 m bay length, 1.0 m bay height	1.35	4.7	50	2621.004	
	for 1.00 m bay length, 1.5 m bay height	1.77	5.7	50	2621.005	
	for 1.00 m bay length, 2.0 m bay height	2.22	7.3	50	2621.015	
	for 2.00 m bay length, 0.5 m bay height	1.96	7.1	50	5611.050	
	for 2.00 m bay length, 1.0 m bay height	2.14	7.6	50	5611.100	
	for 2.00 m bay length, 1.5 m bay height	2.42	7.5	50	5611.150	
	for 2.50 m bay length, 0.5 m bay height	2.44	8.2	50	2621.011	
for 2.50 m bay length, 1.0 m bay height	2.59	8.6	50	2621.009		
for 2.50 m bay length, 1.5 m bay height	2.83	9.4	50	2621.010		
for 3.00 m bay length, 0.5 m bay height	2.93	9.4	50	2621.012		
for 3.00 m bay length, 1.0 m bay height	3.06	9.7	50	2621.013		
for 3.00 m bay length, 1.5 m bay height	3.26	10.3	50	2621.014		

Scaffolding decks, access decks

Our scaffolding decks comply with the requirements of DIN EN 12811.

In the Layher system, depending on the type of application and scaffolding group but also in accordance with your working requirements and priorities, choose from decks made of hot-dip galvanized steel, aluminium, or an aluminium frame with plywood or plastic board. The load-bearing capacity of the overall system must be observed. All the decks in conjunction with the lift-off preventer additionally brace the scaffolding in the horizontal direction. Longitudinal ledgers and horizontal diagonal braces can be omitted at deck level. The claws of the Layher scaffolding decks slide easily during assembly into the U-/O-sections of the transverse ledgers, ensuring unbeatable speed of assembly. Decks with round ledger supports are especially suitable for abrasive-blasting work in order to avoid blasting residue deposits.

The **U-Xtra-N deck** is identical in construction with the robust deck, but is equipped with a glass-fibre-reinforced plastic plate. It is very weather-resistant: No rotting, no fungus growth, no split-open rivet holes. The breaking load of the plastic plate is about 3 times that of dry plywood. The surface has a proven anti-slip structure, which is very easy to clean. Plaster and dirt can be easily removed by using a high-pressure cleaner or a scraper.

Thanks to recesses in the webs, the optimized **Steel deck T4** offers not only savings on weight but also additional possibilities for use in conjunction with 33.7 m steel tubes, Ref. No. 4603.150 (see top picture). Thanks to optimization of the cap of the **Steel deck T4**, precision-fit decking above the rosette is possible (see bottom picture).

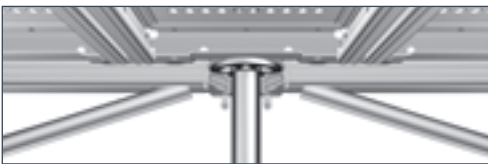

The **Stalu deck, 0.61 m wide**, is an extremely lightweight and durable aluminium deck with a sturdy, riveted steel cap.

When scaffolding planks are used, longitudinal ledgers are required at deck level, as are horizontal diagonal braces in accordance with structural strength requirements. The **O-board bearer**, Ref. No. 2615, is used for scaffolding plank joints which are not covered.

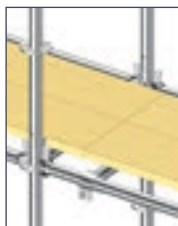

Layher 

More Possibilities. The Scaffolding System.

Scaffolding decks, access decks

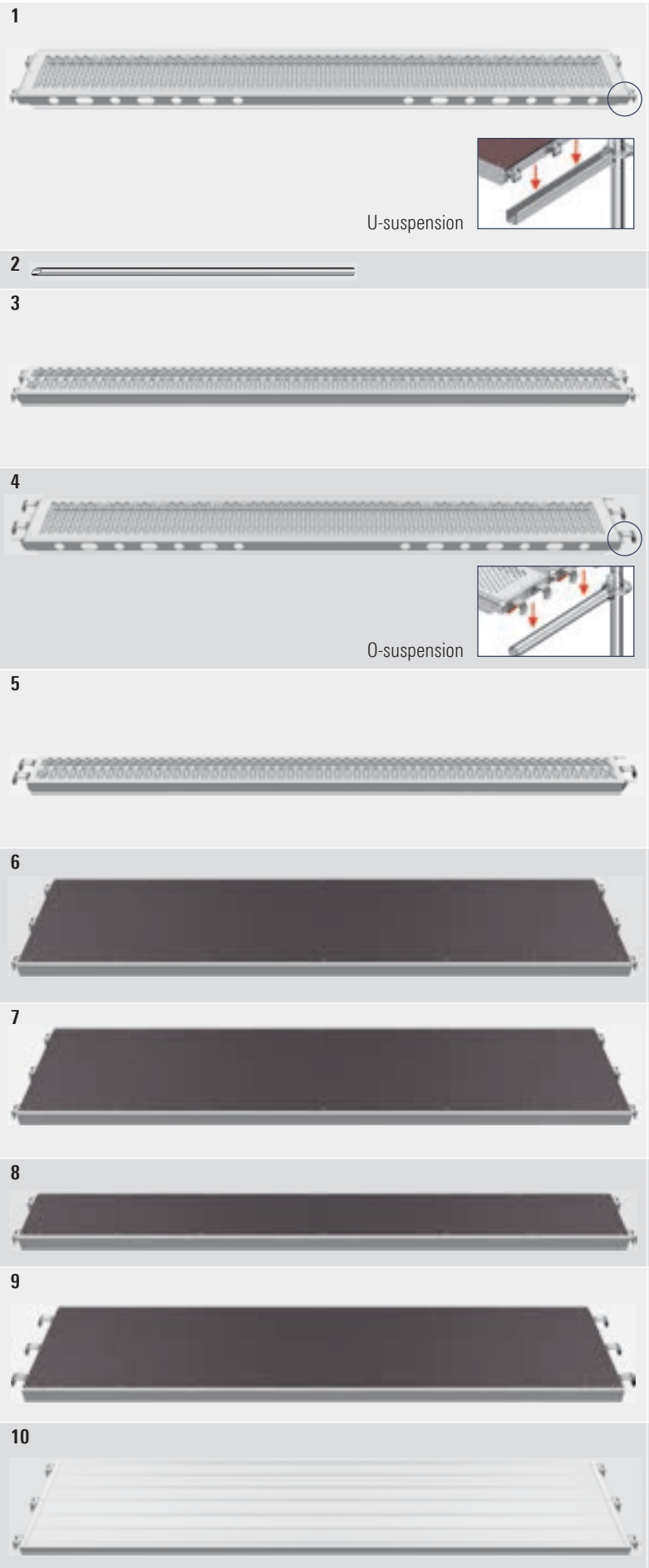

Pos.	Description	Use up to load class	Dimensions L/H x W [m]	Weight approx. [kg]	PU [pcs.]	Ref. No.
1	U-steel deck T4 , 0.32 m wide steel, hot-dip galvanized perforated, non-slip working surface	6	0.73 x 0.32	6.0	60	3812.073
		6	1.09 x 0.32	8.4	60	3812.109
		6	1.29 x 0.32	9.8	60	3802.129
		6	1.40 x 0.32	10.6	60	3802.140
		6	1.57 x 0.32	11.9	60	3812.157
		6	2.00 x 0.32	14.9	60	3802.200
		6	2.07 x 0.32	15.0	60	3812.207
		5	2.57 x 0.32	18.2	60	3812.257
		4	3.07 x 0.32	21.5	60	3812.307
3	4.14 x 0.32	29.8	60	3812.414		
2	Steel tube , dia. 33.7 mm		1.5	3.0	100	4603.150
3	U-steel deck , 0.19 m wide constructed as 3812 as console equalizing deck, e.g. for birdcage scaffolding	6	0.73 x 0.19	5.1	50	3801.073
		6	1.09 x 0.19	6.4	50	3801.109
		6	1.40 x 0.19	8.0	50	3801.140
		6	1.57 x 0.19	8.5	50	3801.157
		6	2.07 x 0.19	10.2	50	3801.207
		5	2.57 x 0.19	13.2	50	3801.257
		4	3.07 x 0.19	15.3	50	3801.307
4	O-steel deck T9 , 0.32 m wide steel, hot-dip galvanized; suspension on O-ledgers; with integrated swivelling lift-off and tilt preventer perforated, non-slip working surface	6	0.73 x 0.32	7.0	30	3862.073
		6	1.09 x 0.32	9.4	30	3862.109
		6	1.29 x 0.32	10.1	30	3862.129
		6	1.40 x 0.32	10.8	30	3862.140
		6	1.57 x 0.32	12.5	30	3862.157
		6	2.07 x 0.32	16.0	30	3862.207
		5	2.57 x 0.32	18.9	30	3862.257
4	3.07 x 0.32	22.5	30	3862.307		
5	O-steel deck T9 , 0.19 m wide steel, hot-dip galvanized; suspension on O-ledgers; with integrated swivelling lift-off and tilt preventer perforated, non-slip working surface	6	0.73 x 0.19	5.0	50	3863.073
		6	1.09 x 0.19	7.0	50	3863.109
		6	1.40 x 0.19	9.0	50	3863.140
		6	1.57 x 0.19	10.0	50	3863.157
		6	2.07 x 0.19	12.7	50	3863.207
		5	2.57 x 0.19	15.5	50	3863.257
4	3.07 x 0.19	18.2	50	3863.307		
6	U-Xtra-N deck , 0.61 m wide aluminium stile section, glass-fibre-reinforced plastic plate extremely durable, lightweight, non-slip working surface	3	0.73 x 0.61	7.0	60	3866.073
		3	1.09 x 0.61	9.5	60	3866.109
		3	1.57 x 0.61	13.0	40	3866.157
		3	2.07 x 0.61	16.2	40	3866.207
		3	2.57 x 0.61	19.0	40	3866.257
		3	3.07 x 0.61	23.5	40	3866.307
7	U-robust deck , 0.61 m wide, aluminium stile section, plywood panel BFU 100G phenolic resin coating and rot protection; lightweight, non-slip, easily stackable	3	0.73 x 0.61	7.2	60	3835.073
		3	1.09 x 0.61	9.7	60	3835.109
		3	1.57 x 0.61	13.1	40	3835.157
		3	2.07 x 0.61	16.4	40	3835.207
		3	2.57 x 0.61	19.3	40	3835.257
		3	3.07 x 0.61	24.2	40	3835.307
8	U-robust deck , 0.32 m wide, constructed as 3835 as console or equalizing deck, e.g. for birdcage scaffolding	6	1.57 x 0.32	9.9	60	3836.157
		5	2.07 x 0.32	11.5	60	3836.207
		4	2.57 x 0.32	14.7	60	3836.257
		3	3.07 x 0.32	16.0	60	3836.307
9	O-robust deck T9 , 0.61 m wide aluminium stile section, plywood panel BFU 100G phenolic resin coating and rot protection; lightweight, non-slip, easily stackable suspension on O-ledger	3	0.73 x 0.61	8.7	60	3870.073
		3	1.09 x 0.61	11.2	60	3870.109
		3	1.57 x 0.61	14.6	40	3870.157
		3	2.07 x 0.61	17.9	40	3870.207
		3	2.57 x 0.61	21.9	40	3870.257
		3	3.07 x 0.61	26.5	40	3870.307
10	U-stalu deck T9 , 0.61 m wide extremely lightweight aluminium deck with sturdy, riveted steel caps, stacking height only 54 mm	6	0.73 x 0.61	6.6	40	3867.073
		6	1.09 x 0.61	8.8	40	3867.109
		6	1.57 x 0.61	11.7	40	3867.157
		5	2.07 x 0.61	14.8	40	3867.207
		5	2.57 x 0.61	17.9	40	3867.257
4	3.07 x 0.61	21.0	40	3867.307		

Scaffolding decks, access decks

The **U-stalu deck**, 0.19 m or 0.32 m wide, is an extremely lightweight and durable aluminium deck with a sturdy, riveted steel cap and high load-bearing capacity.

With the **Connecting clamp for Stalu deck**, several Stalu decks can be connected to avoid offsets in the case of load.

Internal accesses can be built into the scaffolding with the **access decks**. These decks conform to the requirements of DIN EN 12811 and are available with a separate or an integrated access ladder for internal access.



O-suspension



U-suspension

In the case of circular scaffolding, the corners are covered with the U-corner deck, adjustable, with toe board. System-conforming covers are thus no longer a problem. You obtain a continuous deck surface with integrated toe board. Can also be used in the case of special fire protection requirements.

The Access ladder, 7-rungs is a flexible aid to climbing inside the scaffolding to a storey height of 2 m.



Installation situation 45° (Pos. 9)



Installation situation 90° (Pos. 9)

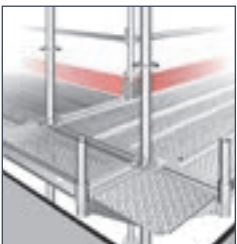

Installation situation (Pos. 10)

Scaffolding decks, access decks

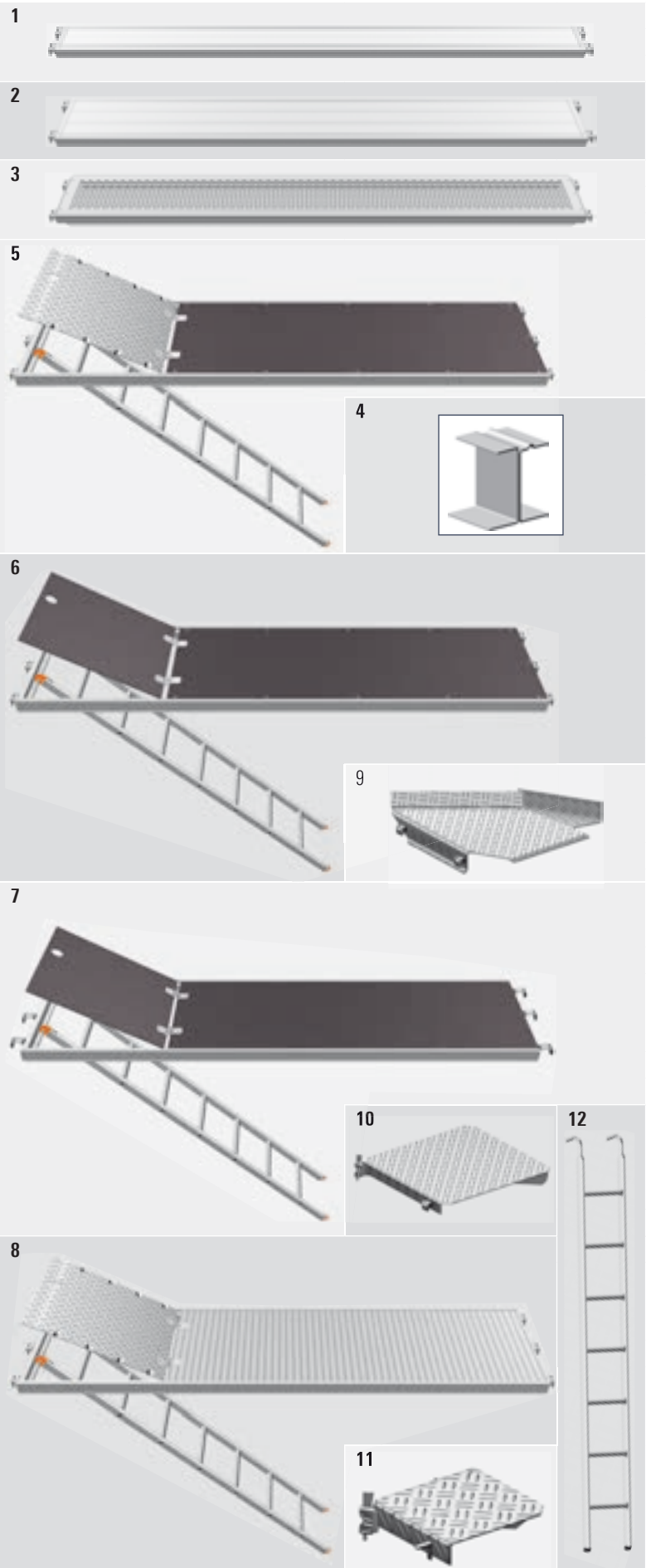

Layher 

More Possibilities. The Scaffolding System.

Pos.	Description	Use up to load class	Dimensions L/H x W [m]	Weight approx. [kg]	PU [pcs.]	Ref. No.
1	U-stalu deck , 0.19 m wide, constructed as 3867 as console or equalizing deck, e.g. with birdcage scaffolding	6	1.57 x 0.19	5.6	50	3857.157
		6	2.07 x 0.19	7.2	50	3857.207
		5	2.57 x 0.19	8.7	50	3857.257
		4	3.07 x 0.19	10.2	50	3857.307
2	U-stalu deck , 0.32 m wide, constructed as 3867 as console or equalizing deck, e.g. with birdcage scaffolding	6	1.57 x 0.32	7.4	60	3856.157 🇩🇪
		6	2.07 x 0.32	9.2	60	3856.207 🇩🇪
		5	2.57 x 0.32	11.0	60	3856.257 🇩🇪
		4	3.07 x 0.32	13.3	60	3856.307 🇩🇪
3	U-aluminium deck , perforated, 0.32 m wide, deck and caps of aluminium with robust steel claws perforated, non-slip working surface	6	1.57 x 0.32	6.5	60	3803.157 🇩🇪
		5	2.07 x 0.32	8.0	60	3803.207 🇩🇪
		4	2.57 x 0.32	10.0	60	3803.257 🇩🇪
		3	3.07 x 0.32	11.5	60	3803.307 🇩🇪
4	Connecting clamp for U-stalu deck			0.1		3856.000 🇩🇪
5	U-Xtra-N hatch-type access deck 0.61 m wide, with integrated access ladder, deck surface of glass-fibre-reinforced plastic, aluminium access hatch	3	2.57 x 0.61	25.4	40	3869.257 🇩🇪
		3	3.07 x 0.61	28.8	40	3869.307 🇩🇪
6	U-robust access deck , 0.61 m wide, with integrated access ladder	3	2.57 x 0.61	24.0	40	3838.257
		3	3.07 x 0.61	27.4	40	3838.307
7	O-robust access deck T9 , 0.61 m wide, with integrated access ladder	3	2.57 x 0.61	25.9	40	3872.257 🇩🇪
		3	3.07 x 0.61	29.7	40	3872.307 🇩🇪
8	U-aluminium access deck , 0.61 m wide, with integrated access ladder	3	2.57 x 0.61	24.9	40	3852.257
		3	3.07 x 0.61	30.5	40	3852.307
9	U-corner deck , steel, adjustable, with toe board for 0.73 m wide scaffolding for angles from 45° – 90°, with toe board, steel	3	0.85 x 0.65	21.5		3819.000 🇩🇪
10	U-corner deck , steel for 0.36 m wide scaffolding for 0.73 m wide scaffolding	3	0.36 x 0.36	6.4	50	2630.037 🇩🇪
		3	0.73 x 0.73	20.8	24	2630.070 🇩🇪
11	U-corner deck , steel for 0.36 m wide scaffolding	3	0.34 x 0.34	6.9	50	2630.040 🇩🇪
12	Access ladder, 7 rungs for access deck Ref. No. 3813 , Ref. No. 3851 , Ref. No. 3871 and Ref. No. 3858		2.15 x 0.35	7.8	70	4005.007



The offset hatch can be opened and closed even when bridging decks are placed on top.



Scaffolding decks, access decks

1



2



3



4



5

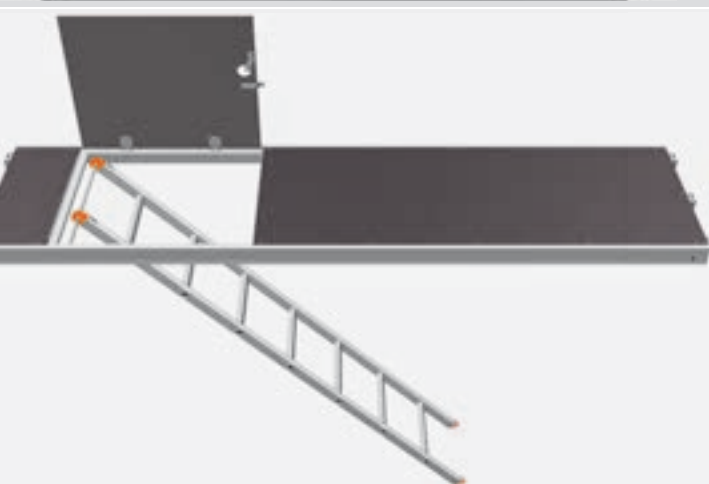

6















7



Layher 

More Possibilities. The Scaffolding System.

Pos.	Description	Use up to load class	Dimensions L/H x W [m]	Weight approx. [kg]	PU [pcs.]	Ref. No.
1	U-access deck , aluminium, 0.61 m wide lightweight access deck with aluminium deck surface and aluminium access hatch	3	1.57 x 0.61	15.1	40	3851.157 
		3	2.07 x 0.61	17.0	40	3851.207 
		3	2.57 x 0.61	20.6	40	3851.257 
		3	3.07 x 0.61	26.1	40	3851.307 
2	O-access deck T9 , aluminium, 0.61 m wide easy access with aluminium deck surface and aluminium access hatch	3	1.57 x 0.61	14.9	40	3871.157 
		3	2.07 x 0.61	17.9	40	3871.207 
3	U-access deck , steel, 0.64 m wide for heavy duty; access hatch aluminium	4	2.07 x 0.64	28.9	30	3813.207 
		4	2.57 x 0.64	38.0	30	3813.257 
4	U-robust access deck , 0.61 m wide, hatch offset	3	1.57 x 0.61	14.2	40	3858.157 
		3	2.07 x 0.61	17.2	40	3858.207 
5	U-robust access deck , 0.61 m wide, hatch offset, with integrated access ladder	3	2.57 x 0.61	25.2	40	3859.257 
		3	3.07 x 0.61	28.4	40	3859.307 
6	U-access deck , aluminium, 0.61 m wide	3	1.00 x 0.61	10.0		3851.100
7	O-access deck , aluminium, 0.61 m wide	3	1.00 x 0.61	10.0		3871.100

Scaffolding decks, access decks

The **Steel plank** is a safe bridging element capable of bearing high loads for all scaffolding systems. It is preferred to wooden planks for use in areas with stringent fire protection requirements.

- ▶ Long service life, reusable
- ▶ Lower weight compared with wooden planks
- ▶ Non-slip and non-inflammable
- ▶ If at least 2 steel planks are adjacent to one another, they may also be used in brick guards.

The support length must be at least 10 cm at every support.

For scaffolding boards of wood see Accessories Catalogue.

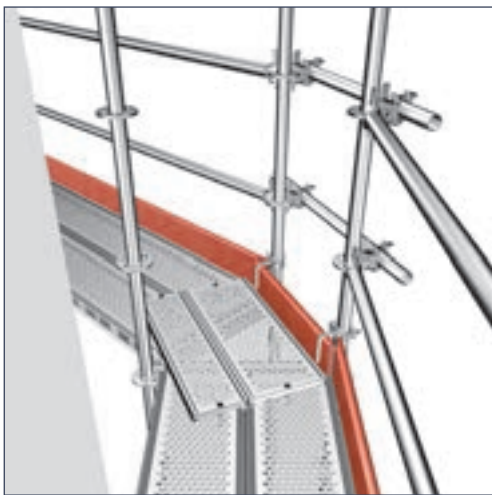

Gap covers



The **steel-gap cover** can be used between two scaffolding decks on SpeedyScaf and Allround Scaffolding. For use on gap widths up to 13 cm.

Scaffolding decks, access decks

1

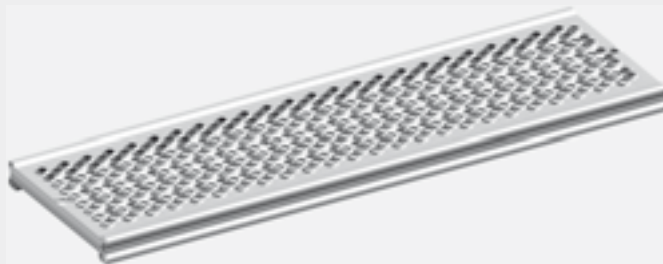

2

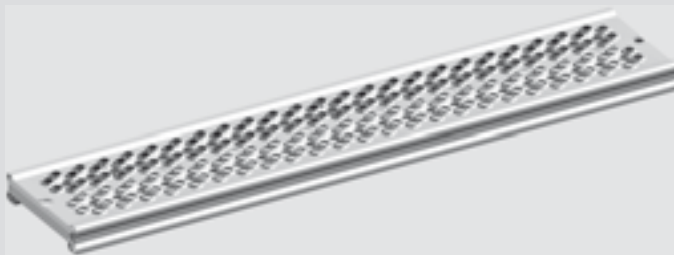

3



4



5



6

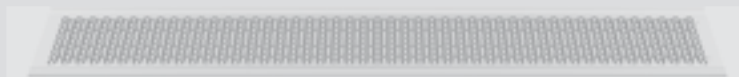

Pos.	Description	Use up to load class	Dimensions L/H x W [m]	Weight approx. [kg]	PU [pcs.]	Ref. No.
1	Steel plank, 0.3 m system-free, completely made of hot-dip galvanized steel	6	1.0 x 0.30	6.5	60	3880.100
		6	1.5 x 0.30	10.3	60	3880.150
		5	2.0 x 0.30	12.8	60	3880.200
		3	2.5 x 0.30	15.3	60	3880.250
2	Steel plank, 0.2 m system-free, completely made of hot-dip galvanized steel	6	1.0 x 0.20	4.8	100	3878.100
		6	1.5 x 0.20	7.2	100	3878.150
		5	2.0 x 0.20	9.5	100	3878.200
		3	2.5 x 0.20	11.8	100	3878.250
3	Locking pin for steel plank, plastic , dia. 11 mm not for multiple use		0.08	0.01	100	3800.001
4	Steel bolt, self securing , dia. 11 x 97 mm		0.08	0.1	50	3800.002
5	Securing screw, 19 WS safe installation and dismantling from the above the working level		0.08 x 0.03	0.1	50	3800.004
6	Steel gap cover, 0.32 m for 0.73 m bay length for 1.09 m bay length for 1.57 m bay length for 2.07 m bay length for 2.57 m bay length for 3.07 m bay length			2.6	150	3881.000
				3.8	100	3881.001
				4.2	100	3881.002
				6.3	100	3881.003
				8.5	100	3881.004
				10.7	100	3881.005

Brackets

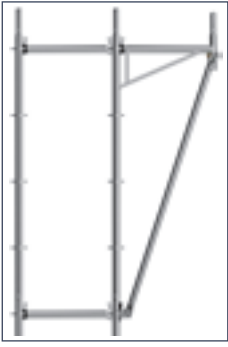

Widening of scaffolding can be easily performed by fitting **Brackets** in the rosette on the standard. System decks in brackets must be secured against lifting off with the **Lift-off preventer**, Ref. No. 2634.

Widened scaffolding can also be constructed with O-ledgers or U-transverse ledgers, base collar and diagonal braces in any projection depending on the working load. Structural strength verification is required here for each individual case.

The **O-bracket, 0.69 m wide, adjustable** is used incrementally and facilitates optimum stand height and wall distance.

The **Bracket brace 2.05 m** is used to support the 0.73 m bracket.

The **Bracket, 1.09 m wide** is used for widening birdcage scaffolding. Transverse ledger at the height of the lower bracket connection is required. Permissible load capacity: 2.0 kN/m² for bay widths 3.07 m.

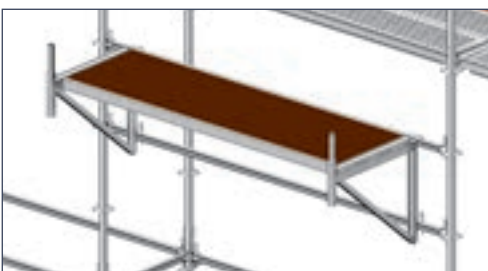

U-bracket, with 2 hooks, suspended from the ledgers, for projecting platforms

Brackets

Original Allround Scaffolding from Layher is made up of more than just standards and ledgers: complete system technology with additional parts and accessories to suit the construction site provides for safety and assembly benefits at all sites. System brackets are available for quickly widening scaffolding bays and for converting projecting building parts and eaves.

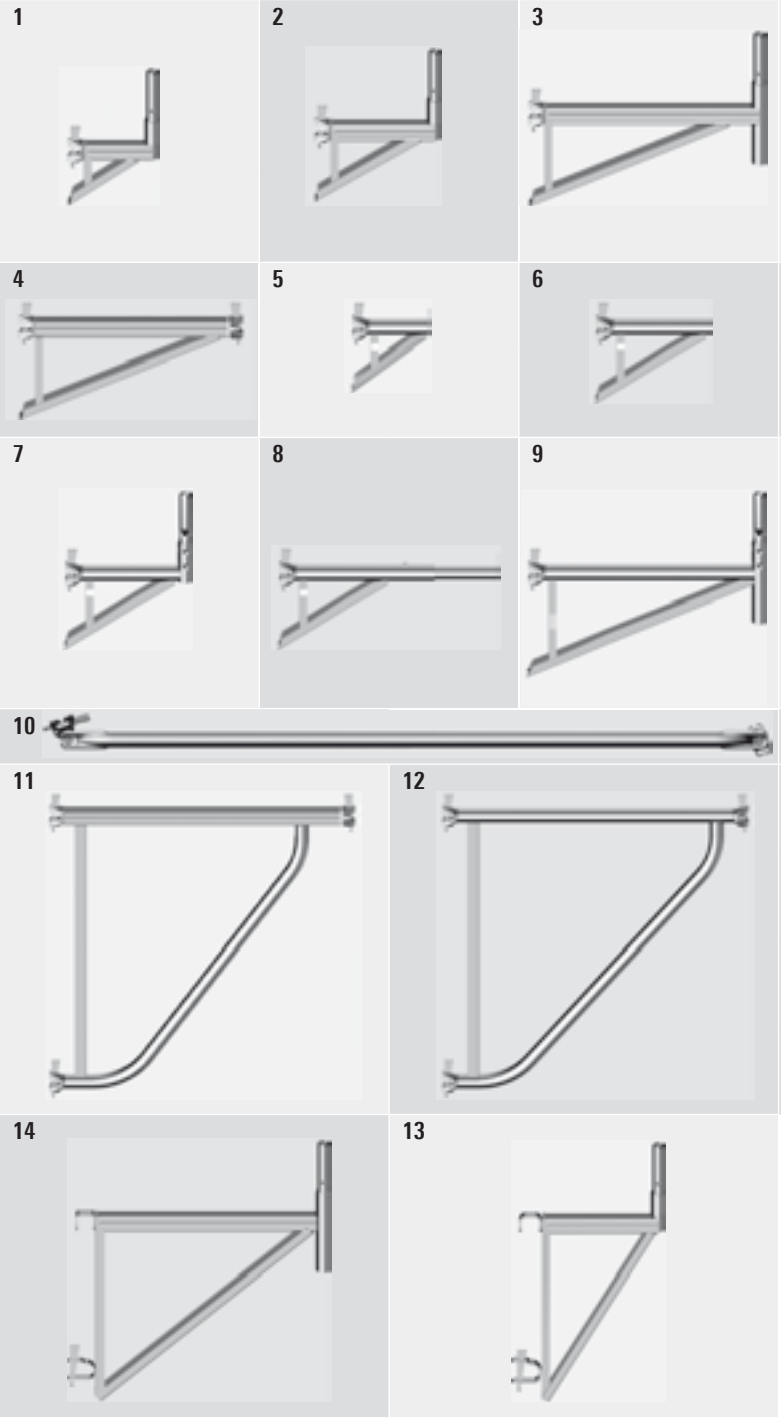

U-lift-off-preventers (see page 16) can be used for all U-console brackets.

Pos.	Description	Dimensions L/H x W [m]	Weight approx. [kg]	PU [pcs.]	Ref. No.
1	U-console bracket , 0.28 m wide for U-deck 0.19 m wide, lift-off preventer provided by customer	0.28	3.4	100	2630.019 
2	U-console bracket , 0.39 m wide for U-deck 0.32 m wide	0.39	3.9	250	2630.039 
3	U-console bracket , 0.73 m wide for 2 U-decks 0.32 m or 1 U-deck 0.61 m wide	0.73	6.4	80	2630.073 
4	U-console bracket , 0.73 m wide, with 2 wedge-heads 0.73 m for U-decks, 2 x 0.32 m or 1 x 0.61 m wide	0.73	5.0	80	2630.074 
5	O-console bracket , 0.26 m wide, without spigot for O-deck 0.19 m wide	0.26	2.3	250	2631.026 
6	O-console bracket , 0.36 m wide, without spigot for O-deck 0.32 m wide	0.36	3.4	100	2630.038 
7	O-console bracket , 0.39 m wide, for O-deck 0.32 m wide	0.39	3.9	250	2631.039 
8	O-console bracket , 0.69 m wide, adjustable pushed in: for accommodating 2 x 0.19 m O-steel decks T4 pulled out: for accommodating 3 x 0.19 m O-steel decks T4	0.69	4.2	300	2630.069 
9	O-console bracket , 0.73 m wide for 2 O-decks 0.32 m or 1 O-deck 0.61 m wide	0.73	6.8	80	2631.073 
10	Bracket brace , 2.05 m	2.05	8.8	50	2631.205 
11	U-console bracket , 1.09 m wide with U-section, for 3 U-decks 0.32 m wide	1.09	12.0	30	2630.109 
12	O-console bracket , 1.09 m wide for 3 O-decks 0.32 m wide	1.09	12.0	30	2631.109 
13	U-console bracket , with 2 hooks, 0.36 m wide for U-deck 0.32 m wide	0.36	6.6	80	4005.036 
14	U-console bracket , with 2 hooks, 0.73 wide for U-deck 2 x 0.32 m wide or 1 x 0.61 m	0.73	8.5	40	4005.073 

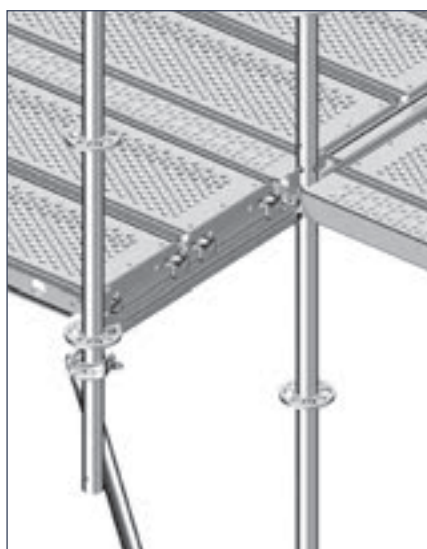

Assembly situation: **U-console bracket**,
0.73 m wide (top) or alternatively
U-ledger 0.73 m in conjunction with
Bracket brace 2.05 m (left).



U-gap decks/U-ledgers with gap cover,
0.11 m wide are available in a variety of
lengths for gap-free work surfaces
between U-main scaffolding decks and
U-console bracket decks
(see pages 42 / 43).

Lattice beams

O-lattice beam, with 4 wedge-heads, steel, Ref. No. 2659 is used for further construction in the scaffolding standard dimension. The top and bottom cylindrical tube chords are secured to the standard with the wedge-heads.

The **U-lattice beam, steel,** Ref. No. 2656, and the **U-lattice beam, aluminium,** Ref. No. 3206, with 4 wedge-heads for locating on standards are used to construct birdcage scaffolding or in conjunction with the **Spigot for U-lattice beam,** Ref. No. 2656.000, for further construction in the scaffolding standard dimension or for bridging.

U-ledger for lattice beam Ref. No. 4923 for accommodating scaffolding decks for bridging with Allround lattice beams.

Applicable to lattice beams: when lattice beams are used, the stability of the scaffolding must be verified in each case. Loading tables available on request. The scaffolding deck must be secured against lifting off in each case with **U-lift-off preventer,** Ref. No. 2657.

The **Lattice beam connection 0.5 m, with 2 wedge-heads** permits a connection between non-system aluminium or steel lattice beams 450 and Allround standards.

Lattice beams

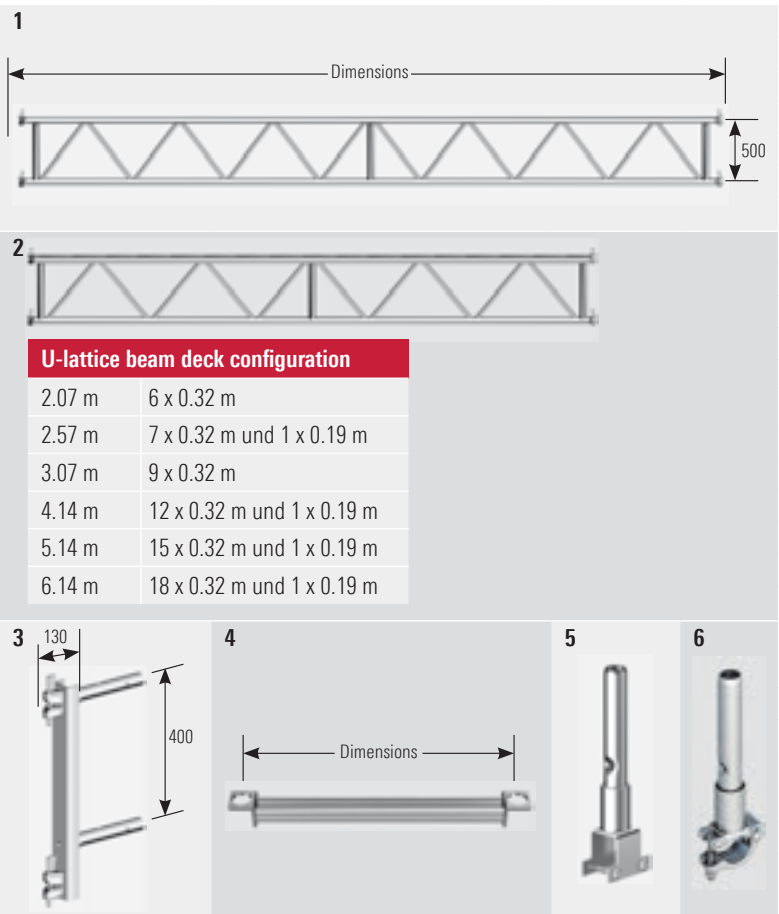

Pedestrian protection, brick guard, scaffolding enclosure

The **U-walkway beam** is designed for further construction with 0.73 m or 1.09 m wide scaffolding. Additional bracing is required for constructing pedestrian passages.

The heightened side protection specified for roofing work is swiftly assembled in Allround Scaffolding: The **side protection nets** are attached at the top, at scaffolding deck height, to the O-ledger. Without a quick strap fastener, the protection net is threaded with each loop of its mesh into the O-ledgers. With quick strap fasteners, the side protection net is attached to the O-ledgers at every 750 mm. Toe board and handrail are required.

Side protection net 10.0 x 2.0 m,
Specification: Mesh width 100 mm, blue, made of PPM 4.5 mm, knotless, as per DIN EN 1263-1, type U

Scaffolding tarpulins and nets

To protect passers-by and traffic during spraying work and other site work causing dirt, façade scaffolding is covered with tarpulins and nets. Layher scaffolding tarpulins and nets meet the requirements of DIN 4420-1. Compliance with design parameters prevents objects falling from the scaffolding level.

Pedestrian protection, brick guard, scaffolding enclosure

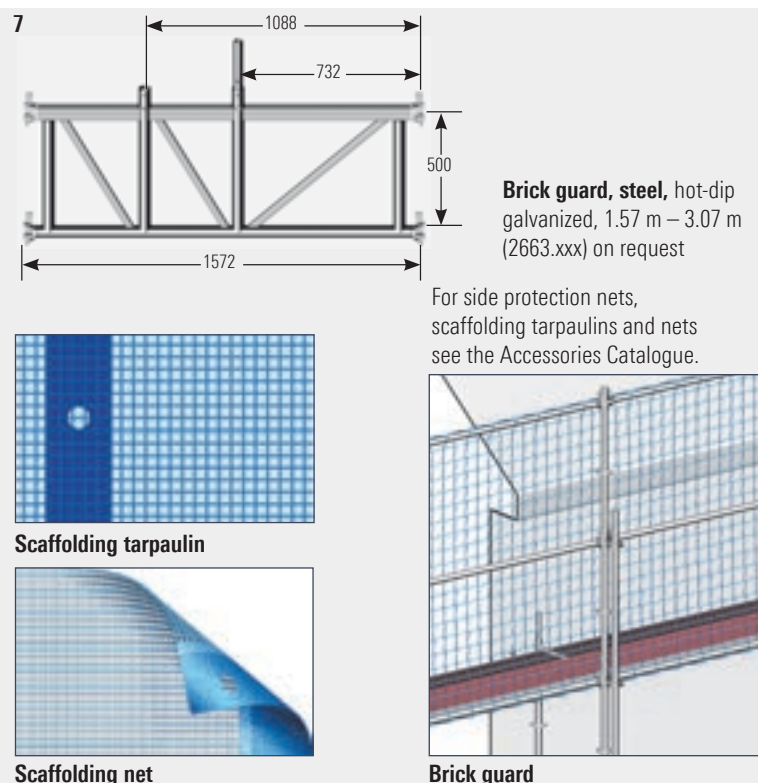

Layher® 

More Possibilities. The Scaffolding System.

Pos.	Description	Dimensions L/H x W [m]	Weight approx. [kg]	PU [pcs.]	Ref. No.	
1	O-lattice beam , with 4 wedge-heads, steel	2.07 x 0.5	26.9	40	2659.207	
		2.57 x 0.5	30.3	40	2659.257	
		3.07 x 0.5	35.6	40	2659.307	
		4.14 x 0.5	44.0	40	2659.414	
		5.14 x 0.5	55.2	40	2659.514	
		6.14 x 0.5	64.2	40	2659.614	
		7.71 x 0.5	82.5	40	2659.771	
2	U-lattice beam , with 4 wedge-heads, steel	2.07 x 0.5	23.4	40	2656.207	
		2.57 x 0.5	29.5	40	2656.257	
		3.07 x 0.5	35.6	40	2656.307	
		4.14 x 0.5	44.0	40	2656.414	
		5.14 x 0.5	54.1	40	2656.514	
		6.14 x 0.5	62.5	40	2656.614	
	U-lattice beam , with 4 wedge-heads, aluminium	1.57 x 0.5	8.6		3206.157	
		2.07 x 0.5	12.3		3206.207	
		2.57 x 0.5	15.2	40	3206.257	
		3.07 x 0.5	17.0	40	3206.307	
		4.14 x 0.5	24.6		3206.414	
		5.14 x 0.5	30.2		3206.514	
		5.14 x 0.5	30.2		3206.514	
3	Lattice beam connection , 0.5 m, with 2 wedge-heads for system-free lattice beams	0.58	8.3	100	4920.050	
4	U-ledger for lattice beam	0.73 m	0.73	3.1	42	4923.073
		1.09 m	1.09	4.3	42	4923.109
5	Spigot for U-lattice beam incl. 2 bolts, also for U-bridging ledger		1.8		2656.000	
6	Spigot for O-lattice beam , with half-coupler for lattice beam and ledger	19 WS		1.8		4706.019
		22 WS		1.8		4706.022

Pos.	Description	Dimensions L/H x W [m]	Weight approx. [kg]	PU [pcs.]	Ref. No.
7	U-walkway beam , 1.57 m wide steel, for scaffolding group 4, up to bay length 3.07 m; max. assembly height 14.0 m	1.57 x 0.5	21.9	25	2665.157



Installation situation: Spigot and U-ledger



U-walkway beam

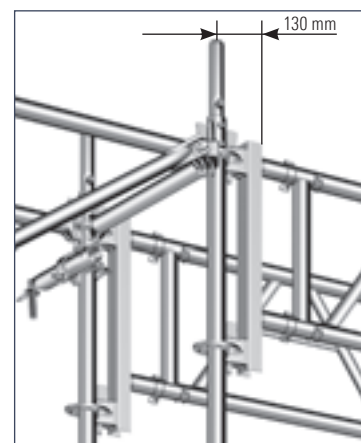

G1 connection 0.5 m, with 2 wedge-heads

WS = wrench size PU = packaging unit = available ex works = delivery time on request = only available in this packaging unit

Allround bridging system

The Allround bridging system is the ideal complement to Layher Allround equipment. With just a few additional components, the load-bearing capacity of the proven Allround system can be increased enough to create, for example, wide-span footbridges or support structures for heavy loads.

The Allround bridging system is available in the familiar Layher dimensions of 2.07 m and 2.57 m, with its unique wedge-head connection making it fully compatible with Layher Allround equipment. Simple bolt connections enable the components of the bridging system to be connected up, resulting in quick and easy assembly.

When used as a support beam for a scaffolding structure, podium or roof structure, the Allround bridging system is connected to the structure above it by using Allround standards integrated into the top. Using the wedge-heads welded onto the sides, even suspended scaffolding structures can be connected, or several bridging units can be connected next to one another for a further increase in the load bearing capacity.

When a footbridge is built, the Allround bridging system is connected to Allround standards using the wedge-heads provided on the sides of the posts. Depending on application, either Event decks or steel decks can be used. The bridge can also be clad using Layher Protect cassettes and roofed. The bridge is mounted on Layher heavy-duty supports with specially designed support elements. These support elements permit pre-assembly on the ground and subsequent insertion by crane, which is a major advantage when spanning bridges across roads.

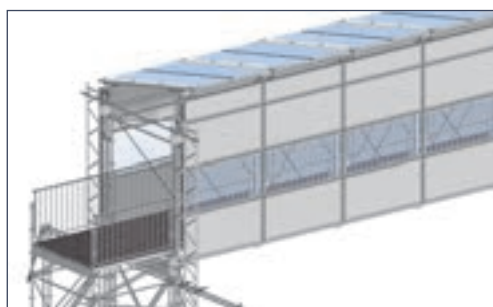



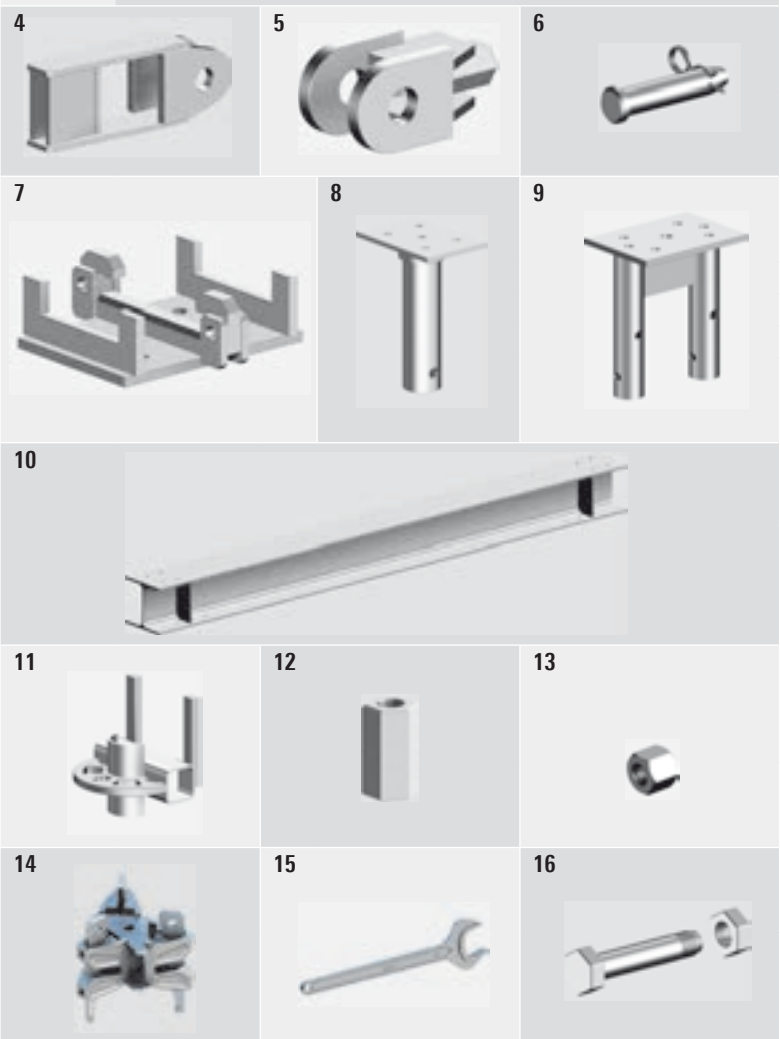
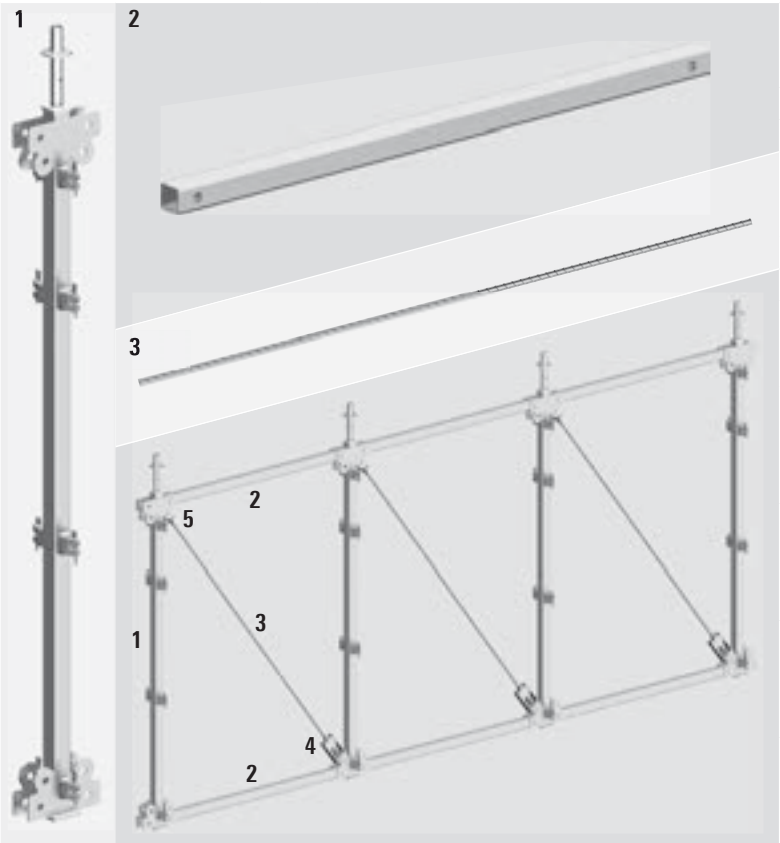























Allround bridging system



Layher® 

More Possibilities. The Scaffolding System.

Pos.	Description	Dimensions L/H x W [m]	Weight approx. [kg]	PU [pcs.]	Ref. No.
1	Post	3.22	56.0	18	2671.000 
2	Chord for 2.07 m bay length for 2.57 m bay length	1.97	20.8	45	2671.010 
		2.47	25.8	45	2671.020 
3	Diagonal rod for 2.07 m bay length for 2.57 m bay length	3.05	7.9	100	2671.030 
		3.37	8.7	100	2671.040 
4	Diagonal anchoring, without nut		5.5		2671.050 
5	Diagonal anchoring, with nut		2.9		2671.060 
6	Bolt 30 mm dia.		0.8	10 	2671.070 
	Securing pin 4 mm dia.		0.01	50 	5905.000 
7	Support element		4.8		2671.080 
8	Adapter for heavy-duty support		5.5		2671.090 
9	Support for double standard		4.9		2671.140 
10	Support beam for bridge width 1.57 m for bridge width 2.07 m for bridge width 2.57 m		119.2	10	2671.095 
			145.8	10	2671.100 
			167.0	10	2671.105 
11	Protect holder		1.0		2671.110 
12	Clamping nut for diagonal rod, WS 36 x 70, galvanized		0.4	10 	2671.120 
13	Locking nut for diagonal rod, WS 36 x 70, galvanized		0.2	20 	2671.130 
14	Wedge-head coupler, triple		2.3		2671.150 
15	Open ended wrench WS 36		0.5		2671.135 
16	Hexagon head bolt M12 x 35, with nut		0.1	50 	2671.160 

Allround shoring TG 60

The **Allround shoring TG 60** ensures a fast, flexible and safe assembly of shoring towers. The Allround shoring TG 60 is able to bear **up to 6 tons per standard**. The structural analysis of the Allround shoring TG 60 complies to DIN EN 12812.

The heart of the TG 60 are the **Shoring frames TG 60** with integrated rosettes. All frames are symmetrical parts, thus the orientation of the diagonal braces can be varied.

The adaptation to the dimension of the formwork beams can be easily made by using different Allround ledgers and diagonal braces from 1.09 m to 3.07 m (see figure "bay length adaptation").

Thanks to the perfect compatibility to Allround Scaffolding, the towers of the TG 60 can be adapted flexibly to any building condition.

The shoring tower TG 60 can be assembled in horizontal position on the ground. Then the tower will be placed by crane. Otherwise it can be assembled in vertical position – optionally directly at the place of action or somewhere else, with placing it with its quickly mounted **Castors**.

The Allround shoring TG 60 has an integrated advanced guardrail without any accessories for assembly in vertical position. For the Allround shoring TG 60, only solid base plates (see page 12) may be used.

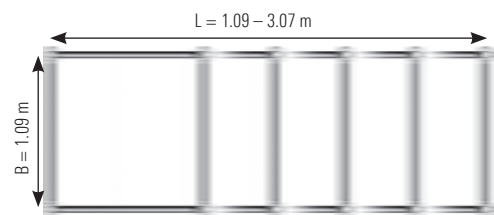

Bay length adaptation with Allround serial ledgers from 1.09 m to 3.07 m.

Get further information from our brochure **Allround Shoring TG 60**.

Compact stairway tower

In its standard version, the compact stairway tower conforms to German regulations on "stairways for building work" and fits into many stairway recesses in buildings to house one or more families. The stairway can be integrated into Allround work scaffolding. The use of standard parts means that only a few additional parts are needed.

Surface area without brackets 1.57 x 1.40 m.
Exit clearances: 2.50 or 2.75 or 3.00 m possible.

Permissible load capacity: 2.0 kN/m²

Layher





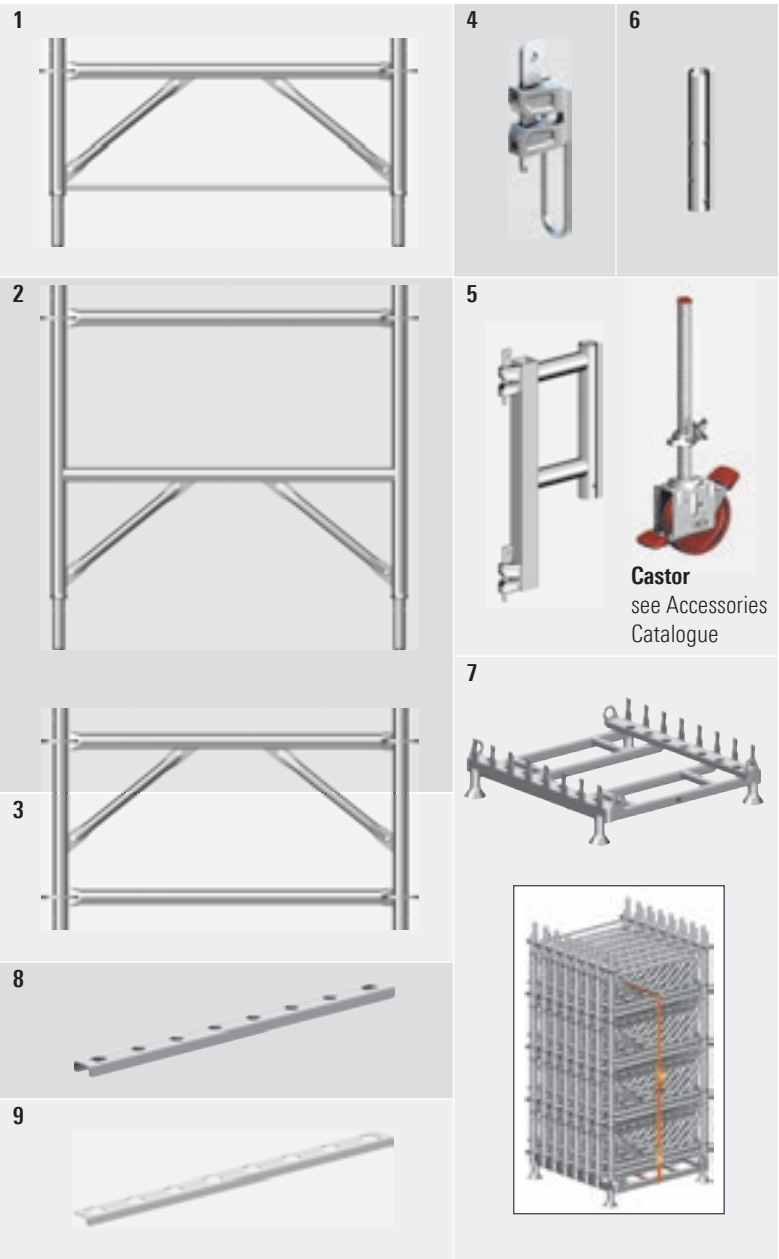

More Possibilities. The Scaffolding System.

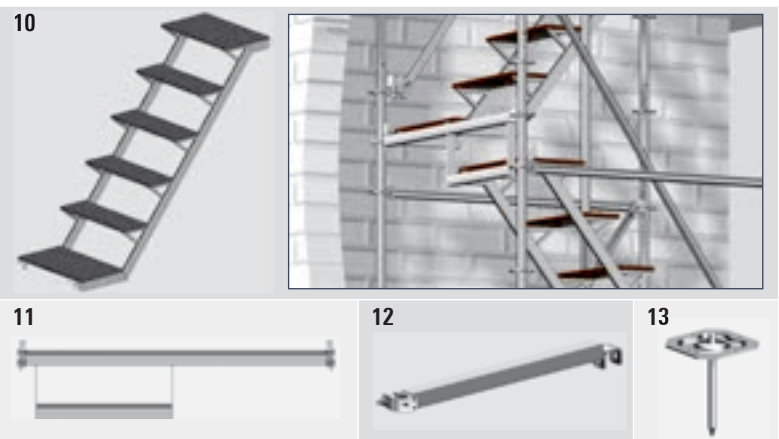



Allround shoring TG 60



Compact stairway tower



Pos.	Description	Dimensions L/H x W [m]	Weight approx. [kg]	PU [pcs.]	Ref. No.
1	Shoring frame TG 60 spacer frame; with spigot at the bottom steel, hot-dip galvanized	0.50 x 1.09	13.0	21	2602.036 
2	Shoring frame TG 60 standard frame, with spigot at the bottom steel, hot-dip galvanized	1.00 x 1.09	17.7	21	2602.035 
3	Shoring frame TG 60 base frame, without spigot; steel, hot-dip galvanized	0.71 x 1.09	15.9	21	2602.034 
4	Spindle support for placement by crane or by castors steel, hot-dip galvanized		0.8	25	2602.033 
5	Castor adapter with 2 wedge-heads		6.4		2602.040 
6	Horing spigot for use of the initial frame as tower head, spigot with cross-drilling for bolting down		1.1		2602.032 
7	Shoring frame pallet for use with 22 shoring frames each level, stackable, craneable, opitimized for truck beds	1.20 x 1.10	53.7		5113.003 
8	Loading and stacking securing profile for use at the stack head with upwards pointing spigots	1.20	3.9		5113.004 
9	Loading and stacking securing profile for use at the stacking head without upwards pointing spigots (e.g. for stacking of initial frames)	1.20	3.4		5113.005 

Pos.	Description	Dimensions L/H x W [m]	Weight approx. [kg]	PU [pcs.]	Ref. No.
10	U-stair , 1.25 x 0.6 m, steel for 1.57 m bay, step height 0.25 m	1.25 x 0.6	32.5	8	2636.125 
11	U-ledger with bearer , 1.40 m for compensating 25 cm, see detailed sketch on left	1.4	9.0	50	2608.140 
12	Gap cover , 0.79 m	0.786	3.4	50	2636.078 
13	Adaptor plate , steel When placing the compact stair tower onto this adaptor plate, it is easily possible to lay the screed	0.15 x 0.15 x 0.2	1.3	20	2636.124 

Platform stairway in Allround Scaffolding



Safe, fatigue-free stairway ascent – also with transportation of materials – without impairment of the working surface. With the **platform stairway**, it is simple to construct a 4-standard stairway tower, either integrated into the scaffolding or as a free-standing access structure anchored on the building. Both parallel and opposite stairways are possible here. There is no hindrance to work on scaffolding with this version. Permissible load capacity: 2.0 kN/m²

The **Comfort stairway** bases on the platform stairway. It is equipped with 175 mm wide, grooved steps. That leads to more comfortable access – especially for high access heights. The stronger stringer profile offers only small bending. Guardrails, internal guardrails and stairwell guardrails can be used from the platform stairwell stairway.



The **Internal stairway guardrail** is required for opposite stairways and serves to increase the stability of single-flight stairways.

The **stairway guardrail post** with the **O-ledger with wedge-head and U-fork** is used for the stairwell at the top level. Optionally the exit of the top stair level can be assembled with console brackets. In that case, the stairwell guardrail is not needed.



Platform stairway in Allround Scaffolding

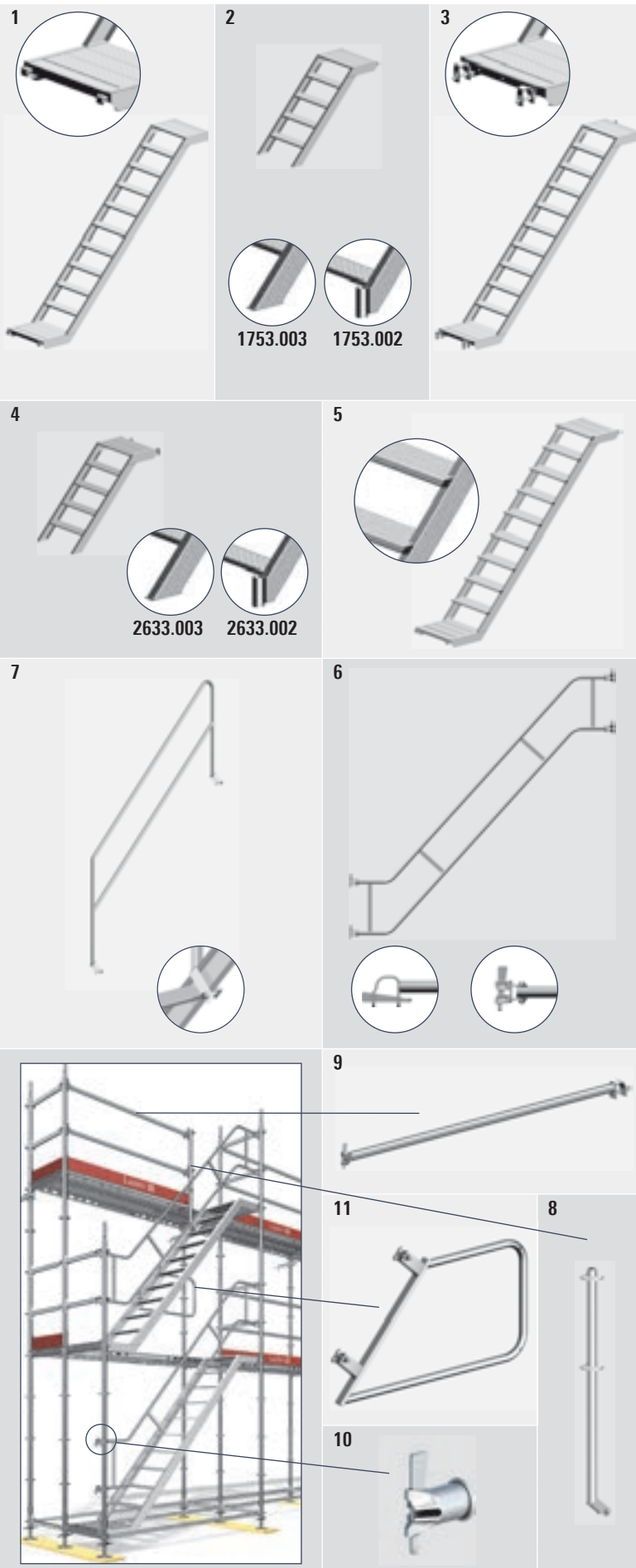

Layher 

More Possibilities. The Scaffolding System.

Pos.	Description	Dimensions L/H x W [m]	Weight approx. [kg]	PU [pcs.]	Ref. No.	
1	U-platform stairway , 2.0 m high, 0.64 m wide, aluminium load-bearing cap. 2.5 kN/m ² , stair class A acc. to EN 12811-1 for 2.57 m bay length; step height 0.20 m for 3.07 m bay length; step height 0.20 m	2.57 x 0.64	21.9	15	1753.257	
		3.07 x 0.64	26.3	15	1753.307	
	U-platform stairway , 1.5 m high, 0.64 m wide, aluminium load-bearing cap. 2.5 kN/m ² , stair class A acc. to EN 12811-1 for 2.57 m bay length; step height 0.18 m	2.57 x 0.64	21.5	15	1753.251	
		3.07 x 0.64	26.3	15	1753.308	
	U-platform stairway , 2.0 m high, 0.94 m wide, aluminium load-bearing cap. 2.5 kN/m ² , stair class A acc. to EN 12811-1 for 2.57 m bay length; step height 0.20 m for 3.07 m bay length; step height 0.20 m	2.57 x 0.94	33.7	15	1753.258	
	3.07 x 0.94	40.1	15	1753.308		
	U-platform stairway , 1.5 m high, 0.94 m wide, aluminium load-bearing cap. 2.5 kN/m ² , stair class A acc. to EN 12811-1 for 2.57 m bay length; step height 0.18 m	2.57 x 0.94	36.6	10	1753.252	
2	U-starting stairway , 0.64 m wide, aluminium 1.00 m high, load-bearing cap. 2.0 kN/m ² ; step height 0.20 m 1.20 m high, load-bearing cap. 2.0 kN/m ² ; step height 0.20 m	1.2 x 0.64	11.5	10	1753.003	
		1.6 x 0.64	13.5	10	1753.002	
	U-starting stairway , 0.94 m wide, aluminium 1.00 m high, load-bearing cap. 2.0 kN/m ² ; step height 0.20 m	1.2 x 0.94	17.0	10	1753.001	
3	O-platform stairway , 2.0 m high, 0.64 m wide, aluminium load-bearing cap. 2,5 kN/m ² , stair class A acc. to EN 12811-1 for 2.57 m bay length; step height 0.20 m for 3.07 m bay length; step height 0.20 m	2.57 x 0.64	23.2	15	2633.257	
		3.07 x 0.64	27.7	15	2633.307	
4	O-starting stairway , 0.64 m wide, aluminium 1.00 m high, load-bearing cap. 2.0 kN/m ² ; step height 0.20 m 1.20 m high, load-bearing cap. 2.0 kN/m ² ; step height 0.20 m	1.2 x 0.64	13.8	10	2633.003	
		1.6 x 0.64	15.3	10	2633.002	
5	U-Comfort stairway , 2.0 m high, 0.64 m wide, aluminium load-bearing cap. 2,5 kN/m ² , stair class B acc. to EN 12811-1 for 2.57 m bay length; step height 0.22 m for 3.07 m bay length; step height 0.22 m	2.57 x 0.64	27.0	15	1755.257	
		3.07 x 0.64	32.0	15	1755.307	
6	Stairway guardrail , 2.0 m high for pos. 1, 3 and 5 for 2.57 m with U-fork for 3.07 m with U-fork for 2.57 m with swivelling wedge-head for 3.07 m with swivelling wedge-head	2.57	18.1	70	2638.257	
		3.07	20.1	70	2638.307	
		2.57	18.0	70	2638.258	
		3.07	21.0	70	2638.308	
	Stairway guardrail , 1.5 m high for pos. 1 for 2.57 m bay length	2.57	17.0	70	2638.251	
7	Internal stairway guardrail T12 , 2.0 m high for pos. 1, 3 and 5 and 2633.257/307	19 WS	2.25	13.5	20	1752.007
		22 WS	2.25	13.5	20	1752.008
	Internal stairway guardrail T12 , 1.5 m high for pos. 1	2.00	11.5	20	1752.012	
	Internal stairway guardrail , 1.0 m high for pos. 2 and 4	0.90	7.8	20	1752.011	
8	Stair guardrail post is used for the stairwell at the top level	19 WS	1.30	6.1	50	2638.400
9	O-ledger with wedge-head and U-fork is used for the stairwell at the top level for 2.57 m bay for 3.07 m bay	1.90	7.8	50	2638.401	
		2.15	8.8	50	2638.402	
10	Stairway guardrail adaptor			0.7	25	2637.000
11	Stairwell guardrail	19 WS		6.2	40	1752.004
		22 WS		6.2	40	1752.014

WS = wrench size PU = packaging unit = available ex works = delivery time on request = only available in this packaging unit

Modular stairway, outside access, construction stairway tower 200

With the **Modular stairway**, accesses that always fit and that match the system can be constructed. Any intermediate dimension can be achieved simply by fitting together the individual stairway parts. The stairway rises 20 cm from step to step, and the bottom element with spindles is used for precise levelling. A wide variety of applications thanks to modular design. Little space needed for transport and assembly.

Height differences from 0.6 m to 1.6 m can be bridged. Load-bearing capacity: 3.0 kN/m². Design: steel, hot-dip galvanized. Connection of elements with **Bolt dia. 12 x 55 mm**, Ref. No. 4905.055, and **Safety clip dia. 2.8 mm**, Ref. No. 4905.000 (2 per joint). (They are already included in the scope of delivery).

Constructing outward-facing access bays requires simple **Scaffolding ladders** together with the **Swing door** and the **Guardrail standard, 1.7 m, bended**.



Layher simple ladders for scaffolding conform to DIN EN 131 individually or when connected to each other. The stile connections must have proper support and be secured with spring clips.

The regulations in BGV C22 must be followed.

Stairway towers can be used in many areas outside scaffolding construction, e.g. in public areas and as escape stairway towers.

The **U-stairway stringer 200, 10-step** and the **Landing-type stairway, aluminium** (see page 38) are not just a quick and comfortable means of upward access which permits problem-free vertical transportation of materials and working on all scaffolding levels, they also easily enable stairway towers of differing widths and load capacities to be built for the purpose of rapidly linking up various construction site levels.

Permissible loading of **U-stairway stringer 200, 10-step**: 2.0 kN/m² for a stair flight width of 1.29 m.

Modular stairway, outside access, construction stairway tower 200

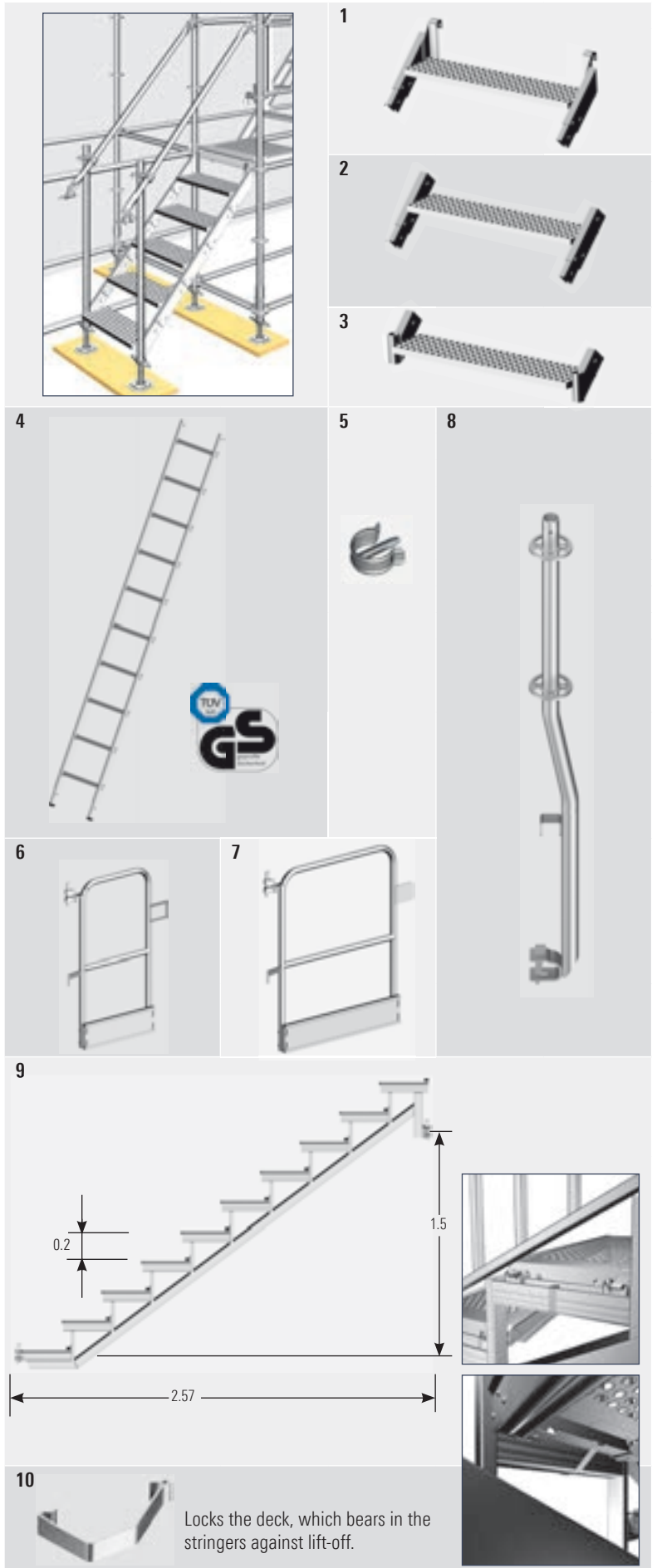

Layher 

More Possibilities. The Scaffolding System.

Pos.	Description	Dimensions L/H x W [m]	Weight approx. [kg]	PU [pcs.]	Ref. No.	
1	U-stair head section , 0.6 m U-stair head section , 0.95 m Spigot preassembled with bolts and safety clips	0.6	10.7	40	2637.060	
		0.95	11.7	50	2637.095 🏠	
2	Stair middle section , 0.6 m Stair middle section , 0.95 m Spigot preassembled with bolts and safety clips	0.6	9.2	50	2638.060	
		0.95	10.2	50	2638.095 🏠	
3	Stair foot section , 0.6 m Stair foot section , 0.95 m	0.6	6.8	50	2639.060	
		0.95	7.8	50	2639.095 🏠	
4	Pole ladder , aluminium	10 rungs	2.9 x 0.46	7.2	50	1004.010
		14 rungs	4.0 x 0.46	10.0	50	1004.014
		17 rungs	4.9 x 0.46	12.0	50	1004.017
		20 rungs	5.7 x 0.46	14.1	50	1004.020
	Pole ladder , steel	6 rungs	1.5 x 0.43	12.0	50	1002.006 🏠
		8 rungs	2.0 x 0.43	15.0	50	1002.008 🏠
		12 rungs	3.0 x 0.43	21.5	50	1002.012 🏠
		16 rungs	4.0 x 0.43	28.0	50	1002.016 🏠
5	Spring clip , 11 mm pin for securing the joint connections of the extended simple steel/aluminium scaffolding ladder Ref. No. 1002/1004		0.1		1250.000	
6	Swing door , 0.73 m, with aluminium toe board	0.73	8.1	40	2627.007 🏠	
7	Swing door , 1.00 m, with aluminium toe board	1.0	9.2	40	2627.006 🏠	
8	Guardrail standard , 1.7 m, bended	1.7	8.5	50	2606.170 🏠	
9	U-stairway stringer 200 , 10-step (2.0 m storey height)	2.0 x 2.57	28.4	40	2638.010 🏠	
10	Lift-off prevention clamp		0.1	20 🏠	2634.030 🏠	

In the 12-standard construction stairway tower 200, the stairways are made up of individual **U-stairway stringers 200, 10-step** and steps made of standard decks. Thus the weights/volumes of the individual parts are lower, the proportions of standard material higher, and the additional costs lower. In addition, different variants of stairway widths are possible.



Stairway towers 500 and 750

Separate stringers and standard decking ensure variable widths for the stairway (1.09 m, 1.57 m, 2.07 m). This keeps the weight and the volume of the components low and permits a high proportion of standard Layher Allround material to be used.

The 16-standard ground plan of the stairway towers 500 and 750 allows both temporary and stationary stairway tower structures of high loading capacity to be built.



The stairway tower 500 is used for preference in non-public areas, e.g. as access to the construction site, as non-public road crossings during construction work or as additional escape stairway tower. In special cases it also can be used in public areas.

U-stairway stringer 500:

- ▶ Permissible load 5.0 kN/m² with a stair flight width of 2.07 m.
- ▶ Stairway dimensions: Riser $s = 20.0$ cm
Tread $a = 27.5$ cm
Undercut $u = 4.5$ cm



The stairway tower 750 with child-protected guardrail is thanks to its riser measures mainly used in public areas and event constructions as access to stages and grandstands. Its features are the high load-bearing capacity and the reduced stairway riser.

U-stairway stringer 750:

- ▶ Permissible load 7.5 kN/m² with a stair flight width of 2.07 m.
- ▶ Stairway dimensions: Riser $s = 16.6$ cm
Tread $a = 31.5$ cm
Undercut $u = 0.5$ cm

A height adjustment outside the 2.0 m or 1.5 m standard dimension is achieved with 5-step stairway stringers (1.0 m high). Alternatively, the stairway stringers 500 and 750 can also be combined in the stairway tower structure.

The stairway tower structures must be verified for each single structure as regards structural strength.

Stairway towers 500 and 750

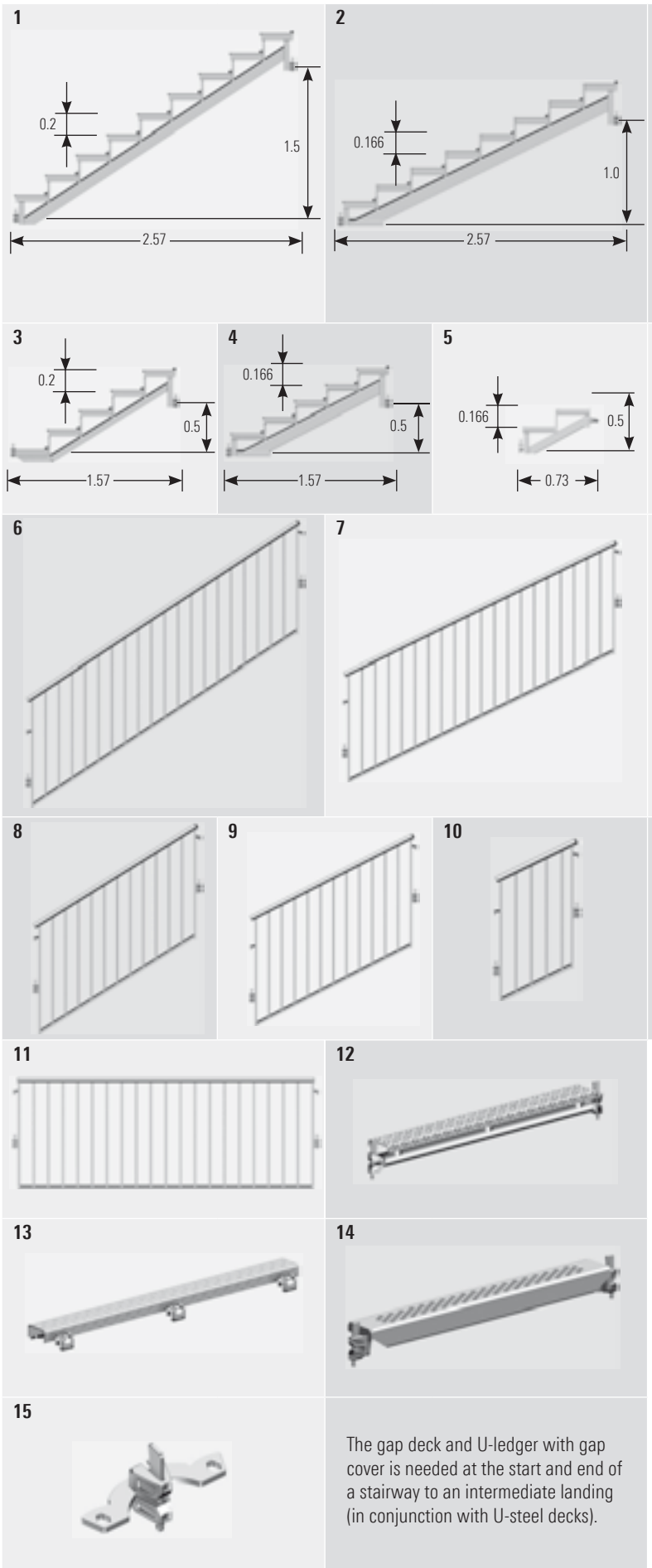

The gap deck and U-ledger with gap cover is needed at the start and end of a stairway to an intermediate landing (in conjunction with U-steel decks).

Layher 

More Possibilities. The Scaffolding System.

Pos.	Description	Dimensions L/H x W [m]	Weight approx. [kg]	PU [pcs.]	Ref. No.
1	U-stairway stringer 500, 9 steps (2.0 m storey height)	2.0 x 2.57	33.6	40	2638.009
2	U-stairway stringer 750, 8 steps (1.5 m storey height)	1.5 x 2.57	36.4	40	2638.008
3	U-stairway stringer 500, 5 steps (1.0 m storey height)	1.0 x 1.57	18.0	40	2638.004
4	U-stairway stringer 750, 5 steps (1.0 m storey height)	1.0 x 1.57	19.2	40	2638.005
5	U-stairway stringer 750 T12, 2 steps (0.5 m storey height)	0.5 x 0.73	8.9	40	2638.002
6	Guardrail for stairs 500 T12, 9 steps (2.0 m storey height)	2.0 x 2.57	35.8	25	2616.100
7	Guardrail for stairs 750 T12, 8 steps (1.5 m storey height)	1.5 x 2.57	34.6	25	2616.101
8	Guardrail for stairs 500 T12, 5 steps (1.0 m storey height)	1.0 x 1.57	24.8	25	2616.104
9	Guardrail for stairs 750 T12, 5 steps (1.0 m storey height)	1.0 x 1.57	24.3	25	2616.105
10	Guardrail for stairs 750 T12, 2 steps (0.5 m storey height)	0.5 x 0.73	14.8	25	2616.110
11	Guardrail with child protection	0.73	14.1	25	2616.073
		1.09	17.8	25	2616.109
		1.29	19.4	25	2616.129
		1.40	20.6	25	2616.140
		1.57	22.7	25	2616.157
		2.07	27.7	25	2616.207
		2.57	32.7	25	2616.257
12	U-ledger with gap cover, 0.11 m with	0.73	5.7	50	2609.073
		1.09	8.3	50	2609.109
		1.29	9.9	50	2609.129
		1.40	10.0	50	2609.140
		1.57	11.9	50	2609.157
		2.07	15.2	50	2609.207
		2.57	18.6	50	2609.257
13	U-gap cover with claws	1.09	5.0	50	3868.109
		1.40	6.5		3868.140
		1.57	7.3	50	3868.157
		2.07	9.7	50	3868.207
14	U-gap deck, 0.11 m with wedge-heads	0.73	4.5	150	2602.073
		1.09	5.9	50	2602.109
		1.40	6.9	50	2602.140
		1.57	7.8	50	2602.157
		2.07	8.5	50	2602.207
		2.57	10.1	50	2602.257
15	Guardrail fixing device		0.8	25	2636.000



Stringers and guardrails

Modular stairway at scaffolding

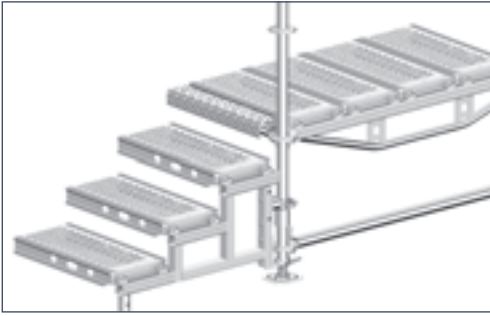

Modular stairway at Event stage

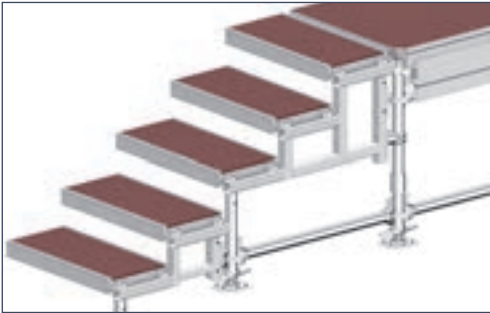

Stringers and guardrails

1 + 2 + 3

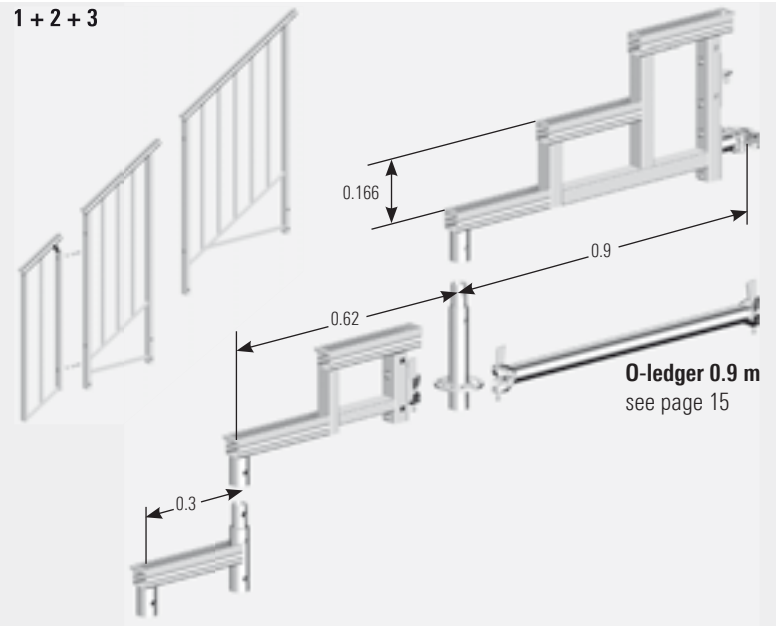

4



Couplers

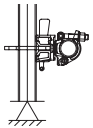

The **wedge-head coupler** serves to connect 48.3 mm dia. scaffolding tubes to the rosettes of the standards.

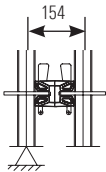

The **twin wedge coupler** is for connecting several standards to each other, e.g. for combining standards in support scaffolding construction.

Couplers



For further couplers see Accessories Catalogue.

Spare Parts, Accesories and Anchoring

Scaffolding must be anchored vertically to and parallel with the façade with resistance to both tensile and compressive stress. **The Allround wall tie 0.80 m** must be secured with a standard coupler to the standard and supported with the fork plate on the U-section of the transverse ledger.

Spare Parts, Accesories and Anchoring

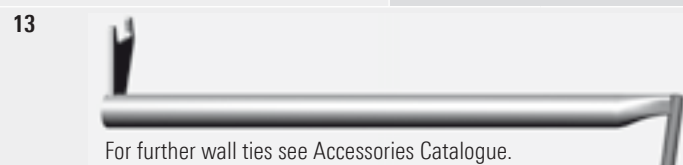
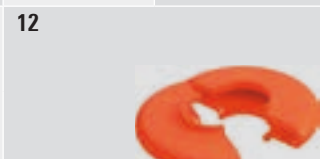
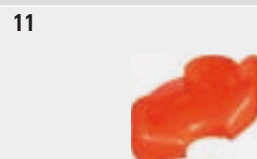

For further wall ties see Accessories Catalogue.

Layher 

More Possibilities. The Scaffolding System.

Pos.	Description	Dimensions L/H x W [m]	Weight approx. [kg]	PU [pcs.]	Ref. No.	
1	Stringer for modular stairway	1-step		2.4	50	5407.001
		2-step		5.5	50	5407.002
		3-step		8.0	40	5407.003
2	Guardrail for modular stairway	1-step		6.5	40	5407.011
		2-step		14.0	25	5407.012
		3-step		16.0	25	5407.013
3	Base collar 0.26 m, for modular stairway with spigot			2.0		5407.021
4	Lift-off preventer with bolt	0.29		0.4		5407.030

Pos.	Description	Dimensions L/H x W [m]	Weight approx. [kg]	PU [pcs.]	Ref. No.	
5	Wedge-head coupler, rigid	19 WS		1.4	25	2628.019
		22 WS		1.1	25	2628.022
6	Wedge-head coupler, swivelling	19 WS		1.5	25	2629.019
		22 WS		1.5	25	2629.022
7	Twin wedge coupler			1.2	25	2628.000

Pos.	Description	Dimensions L/H x W [m]	Weight approx. [kg]	PU [pcs.]	Ref. No.	
10	Wedge, 6 mm with truss head rivet 5 x 11 mm			3.3	25	6494.916
11	Truss head rivet, 5 x 11 mm for securing the wedge 6 mm			1.0	100	6494.836
12	Blind rivet, 4.8 x 12 mm for securing the wedge 6 mm			0.5	100	6493.323
13	Allround rosette cover with connected ledger Polyethylene, fixing with disposable tie 6241.000			0.1	10	4007.001
14	Allround rosette cover without connected ledger Polyethylene, fixing with disposable tie 6241.000			0.1	10	4007.002
15	Allround wall tie, 0.80 m	0.8		3.3		2639.080

WS = wrench size PU = packaging unit = available ex works = delivery time on request = only available in this packaging unit

Flat roof side protection

According to German regulations BGV C22 relating to construction work, a fall protection system must be provided for work areas and walkways on roofs where the height of the fall is more than 3.0 m. The flat roof guardrail meets these requirements for safeguarding flat roofs and has GS-tested certification. A few parts (e.g. **Flat roof guardrail post**, **Flat roof shift preventer**, **Flat roof guardrail stiffener**, **Flat roof ballast 19 kg**, **Support for flat roof guardrail**, **Wheel set** and **Toe board support**) in addition to the already provided ledgers enable variable fall protection systems to be assembled quickly and easily. The maximum ledger length between two **Flat roof guardrail posts** is 3.07 m.

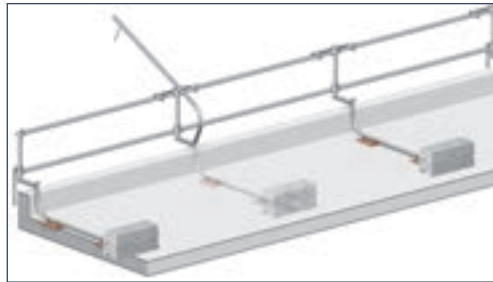

Flat roof side protection

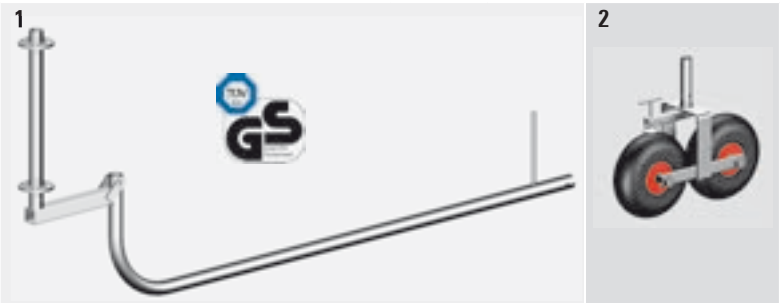

Always comply with instructions for assembly and use.

Fall protection

Preventing falls during assembly, modification or dismantling of the scaffolding

In line with local regulations or as the result of a risk analysis performed by the scaffolding erector, personal protection equipment (PPE), an advance guardrail or a combination of the two may be necessary for assembly, modification or dismantling of the scaffolding.

The Layher advance guardrail system (AGS) consists of two basic components – advance guardrail post and advance telescopic guardrail. The advance guardrail post must be used depending on local regulations.

The **advance guardrail post**, the **advance telescopic guardrail 1.57/2.07 m**, the **advance telescopic guardrail 2.57/3.07 m**, and the **End-AGS** are used for temporary protection against falls during assembly of scaffolding parts on the uppermost, unsecured scaffolding level.

Fall protection

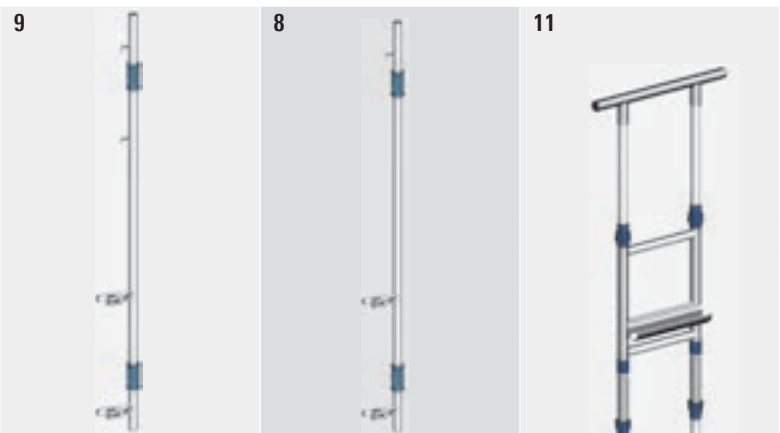

Extension lengths





Extension lengths	L min.	L max.
Advance guardrail 1.57/2.07 m	1.57 m	2.90 m
Advance guardrail 2.57/3.07 m	2.20 m	3.70 m

Layher® 

More Possibilities. The Scaffolding System.

Pos.	Description	Dimensions L/H x W [m]	Weight approx. [kg]	PU [pcs.]	Ref. No.
1	Flat roof guardrail post steel	2.4	13.7	20	2666.010
2	Flat roof wheel set	0.6 x 0.5	6.4		2666.015 
3	Flat roof guardrail stiffener steel	0.6	4.1		2666.030
4	Flat roof shift preventer steel	0.5	1.9		2666.020
5	Support for flat roof guardrail	0.3 x 0.23	0.6		2666.050
6	Flat roof ballast 19 kg	0.69 x 0.25 x 0.16	19.0		2666.060
7	Flat roof toe board support	0.04 x 0.13 x 0.13	0.7		2666.070



Pos.	Description	Dimensions L/H x W [m]	Weight approx. [kg]	PU [pcs.]	Ref. No.
8	Advance guardrail post , aluminium for advance guardrail (1 m height); fast guardrail assembly with a tilting pin		4.2	50	4031.001 
9	Advance guardrail post , aluminium for two advance guardrails (0.5 m and 1 m height); fast guardrail assembly with a tilting pin		4.3	50	4031.002 
10	Advance guardrail , 1.57 / 2.07 m, aluminium Advance guardrail , 2.57 / 3.07 m, aluminium	1.7	3.2	50	4031.207 
		2.3	4.0	50	4031.307 
11	End advance guardrail , aluminium, single		9.8	6	4031.000 



The advance guardrail system (AGS) can be used for the access bay or over several bays.

The instructions for assembly and use of the Allround Scaffolding System must be complied with.

Detail of assembly of the AGS in the access bay



The end-AGS is used by placing the bottom U-section on the lower guardrail. The upper U-section must be pulled down to fit into place under the deck ledger. By letting go the end-AGS will be secured.

WS = wrench size PU = packaging unit  = available ex works  = delivery time on request  = only available in this packaging unit

Safety gear

According to German BGV C22 regulations, equipment to prevent falls by personnel must be provided for work areas and walkways where the height of the fall is more than 2.0 m.

The **PSA safety harness AX 60 C** has impressive features:

- ▶ Comfortable, padded and ergonomic back support
- ▶ Convenient tool holders and click-locks for easy fastening
- ▶ High operational dependability and absolute freedom from maintenance, plus very simple fastening
- ▶ Operating errors are not possible, as the equipment operates in any position
- ▶ Excellent running even under gruelling working conditions
- ▶ Enormous distribution of forces in the event of a fall.

Before use, visual checks must be performed regularly to ensure correct working order. In accordance with German BGR 198 regulations, all personal safety equipment must be inspected at least once a year by an expert. The maximum permissible period of use for the equipment must not be exceeded.

Safety gear



Railing clamp

Railing clamp

According to German regulations BGV C22 relating to construction work, a fall protection system must be provided for work areas and walkways on roofs and intermediate levels where the height of the fall is more than 2.0 m. The Layher railing clamp meets these requirements for securing of concrete floors and fascias of 16 – 33 cm height and of flat roofs.

The back guard must be made in accordance with applicable regulations from tube/coupler, modular or frame scaffolding. The bay widths can be freely selected, max. 3.07 m long.

Railing clamp

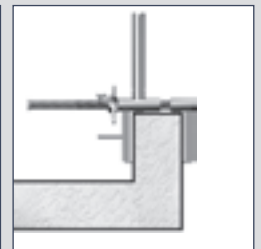
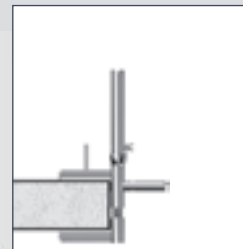
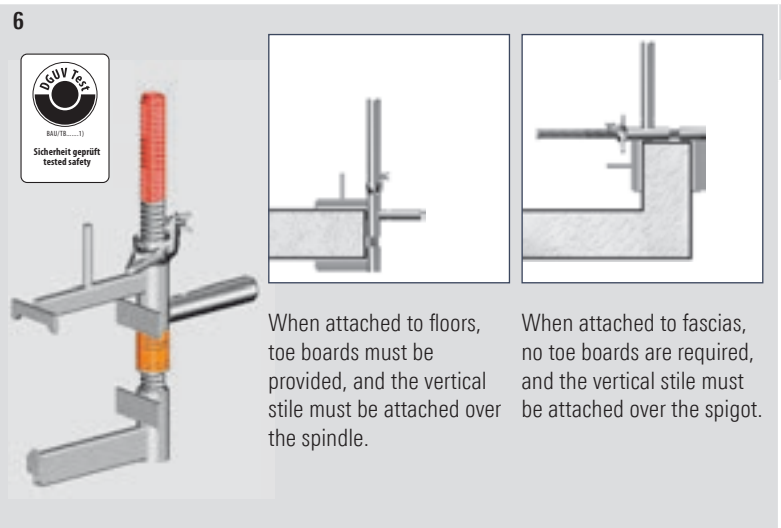

When attached to floors, toe boards must be provided, and the vertical stile must be attached over the spindle.

When attached to fascias, no toe boards are required, and the vertical stile must be attached over the spigot.

Layher

More Possibilities. The Scaffolding System.

Pos.	Description	Dimensions L/H x W [m]	Weight approx. [kg]	PU [pcs.]	Ref. No.
1	PSA safety harness AX 60 C with extension 0.5 m conforms to EN 361		1.8		5969.160
2	PSA backpack , without content		0.6		5969.800
3	PSA-Flex safety rope , 2.0 m with fall arrester and snap hook FS 90, as per EN 354/EN 355 self-shortening to reduce tripping hazards	2.0 m	1.1		5969.501
4	PSA safety rope , 1.5 m with fall arrester and snap hook FS 90, as per EN 354/EN 355	rope 1.5 m	1.1		5969.400
5	PSA Scaffolding construction set Pos. 1 – 3 Safety harness, safety rope 2.0 m, backpack (use exclusively for scaffolding construction)		3.5		5969.170

Pos.	Description	Dimensions L/H x W [m]	Weight approx. [kg]	PU [pcs.]	Ref. No.
6	Railing clamp	0.58	7.0		4015.100

Example for use of the railing clamp on fascia:



Example for use of the railing clamp on floor slab:



WS = wrench size PU = packaging unit = available ex works = delivery time on request = only available in this packaging unit

Layher LayPLAN

Planning of façade scaffolding using a computer is now even easier: the new LayPLAN software simply makes proposals for scaffolding, then calculates the expense of assembly and dismantling, and provides printed out plans for more safety at the site. Complete scaffolding in just three steps:

- ▶ Step 1: Plan out the scaffolding with the clearly structured LayPLAN software.
- ▶ Step 2: The printed-out plan provides you with the legal safeguard required by BetrSichV and assists you in your logistics.
- ▶ Step 3: Planning saves you time when assembling the scaffolding – all the material needed is at the site.

The clearly structured interface of LayPLAN is self-explanatory. This obviates the need for user courses or the study of thick manuals. A compact set of instructions is provided on the program CD.

LayPLAN

Allround Scaffolding
MODULAR SCAFFOLDING

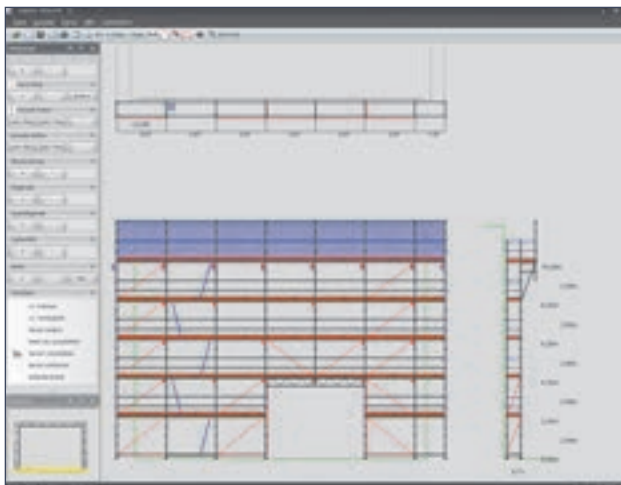

Allround
Façade
scaffolding

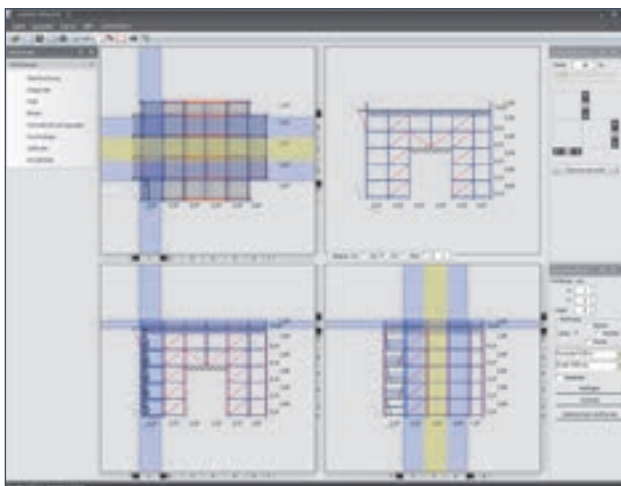

Allround
birdcage
scaffolding

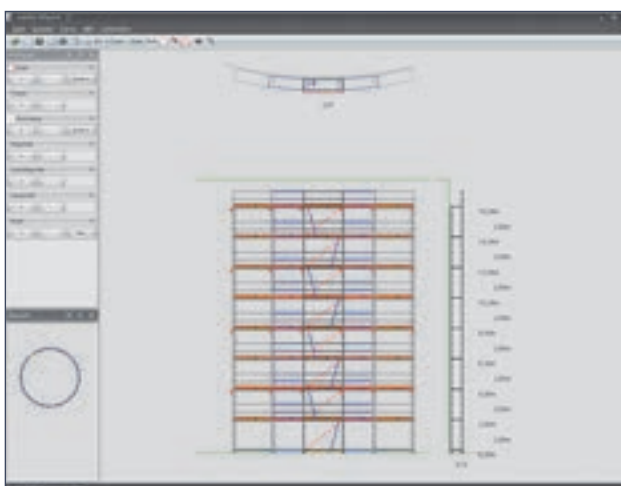

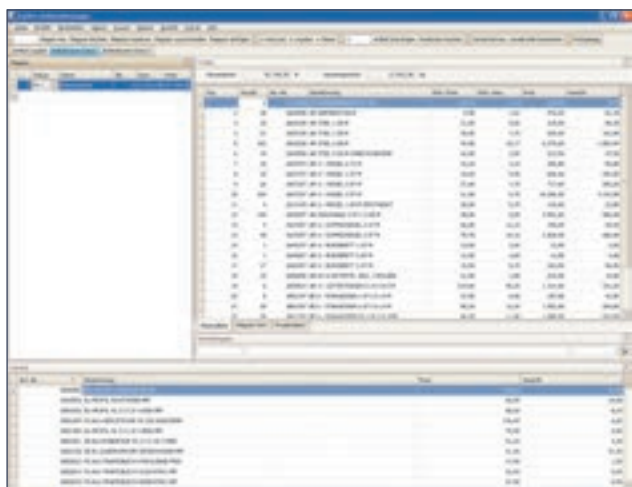

Allround
circular
scaffolding

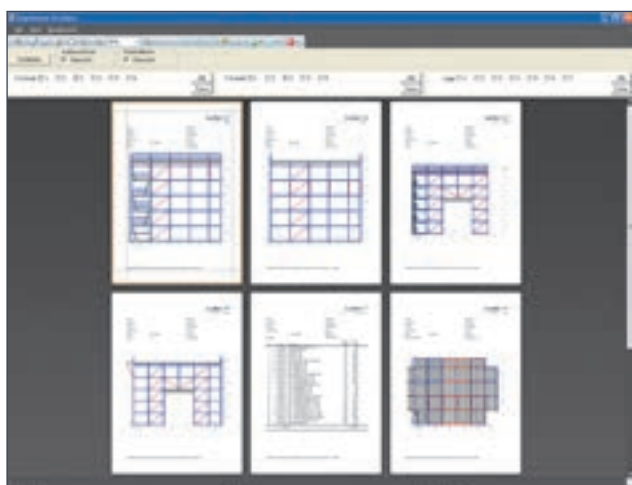

LayPLAN Material Manager



LayPLAN Print Manager

Pos.	Description		Ref. No.
1	SINGLE LICENCE LayPLAN Allround Scaffolding System		6345.400 
2	FOLLOW-UP LICENCE LayPLAN Allround Scaffolding System		6345.401 

WS = wrench size PU = packaging unit  = available ex works  = delivery time on request  = only available in this packaging unit

	SpeedyScaf
	Allround Scaffolding
	Accessories
	Protective Systems
	Shoring
	Event Systems
	Rolling Towers
	Ladders



// Proximity to the customer is a central factor behind Layher's success – geographically speaking too. Wherever our customers need us, we will be there – with our advice, assistance and solutions.



// Headquarters in Eibensbach



// Plant II in Gueglingen

// Layher is your dependable partner with more than 60 years of experience. "Made by Layher" always means "Made in Germany" too – and that goes for the entire product range. Superb quality – and all from one source.

Layher 

More Possibilities. The Scaffolding System.

Wilhelm Layher GmbH & Co. KG
Scaffolding Grandstands Ladders

Ochsenbacher Strasse 56
D-74363 Gueglingen-Eibensbach
Germany

Post Box 40
D-74361 Gueglingen-Eibensbach
Germany

Telephone +49 (0) 71 35 70-0
Telefax +49 (0) 71 35 70-2 65
E-Mail: export@layher.com
www.layher.com